

BASIC GUIDE & RENTAL CATALOG

FRAME SCAFFOLD - SYSTEM SCAFFOLD
SWING STAGE - PROTECTION - CLIMBERS



**NATIONAL
SCAFFOLD**



**SCAFFOLD
DIVISION**
MILWAUKEE, WI

7807 Lake Drive
Lino Lakes, MN 55112
651-636-4320

www.apiconst.com/scaffold_services

2274 Capp Road
St Paul, MN 55114
651-646-4600

www.scafserv.com

2725 S 163rd Street
New Berlin, WI 53151
262-923-9621

www.apiconst.com/scaffolding



**NATIONAL
SCAFFOLD**



**SCAFFOLD
DIVISION**
MILWAUKEE, WI

TABLE OF CONTENTS

Disclaimer	2
Basic Supported Scaffold Types	3
Commonly Asked Rules of Scaffolding	4
General Requirements for Erecting, Use & Dismantle of Scaffold	5
General Components of Scaffold: Frame & System Styles	6
Foundation & Sills	6
Frames	7
Bracing	8
Ties	10
Planking	11
Wood Planking (Special Requirements)	12
Loads	13
Guardrail & Toe boards	13
Enclosures for Scaffold	14
Side arms & End arms	14
Quick Frame & Brace Count Chart	15
Frame Brace Lock & Safety Pins	16
Other Miscellaneous Components	17
System Scaffold	18
Basic Set Up Procedure for System Scaffold	19
Basic Components	20
Other System Component	21
Basic Suspended Scaffold Types	22
General Requirements for Erecting, Use & Dismantle of supported Scaffold	22
Commonly Asked Rules of Scaffolding	23
General Components of Supported Scaffolding	24
Support System	24
Suspension System	26
Motors	26
Power Supply & Cables	26
Work Platforms	27
Temporary Roof Protection	29
Safety System	30
Anchor Devices	31
Body Wear Devices	31
Connecting Devices	31
Material Handling	32
PROTECT-IT Roof System	33
Protect-it Application & Components	34
Fraco FMC-3	35
Beta Max MC4000/3000 Transport Platform	36
Debris Chutes	37
Shoring & Beams	39
Competent Person Training	41
Code Safe Practice Scaffold	42
Code Safe Practice Swing	44

DISCLAIMER

It is always in your best interest to have professionals like us design and install scaffolding, but if not the intention of this book is to give the customer a basic understanding of scaffolding and what is available to them to help them access the work to be performed in a safe manor. It is not to be deemed the “bible” of scaffolding, nor is it all inclusive of all regulations. In no way shape or form does it replace the federal safety standards for scaffolds used in the construction industry covered in 1926.450 Subpart L. Nor is the guide intended to supersede any state, local or your own corporate safety policies. While we take every effort to ensure the accuracy of the information contained in our catalog, we do not accept any responsibility for any errors which may occur herein or for any loses of any kind that may be incurred.

A competent person must be present during erection and dismantle, inspect each day before use and during any alteration of original set. We provide the training needed (sanctioned by the SAIA) for your company to deem you the competent person. Call for next available class.

SCAFFOLDING (*scaf. fold.ing*) defined as a temporary elevated platform either supported from below or suspended from above and its supporting structure (including anchorage point), used for supporting employees or material or both.



BASIC SUPPORTED SCAFFOLD TYPES

There are three basic types of scaffolding available in the United States for use in the construction industry. Most common is welded frame scaffold. For industrial type work, system scaffold along with tube and clamp are more prevalent.

Welded Frame Scaffolding

Welded frame scaffold is used where there is little restriction as to set up. They are popular with the mason, plasterers and general construction. They can be something as simple as a rolling tower or a more elaborate large platform. Welded frame scaffold is simple and fast to set to provide access to work areas. You can also purchase fiber glass and all aluminum scaffold.

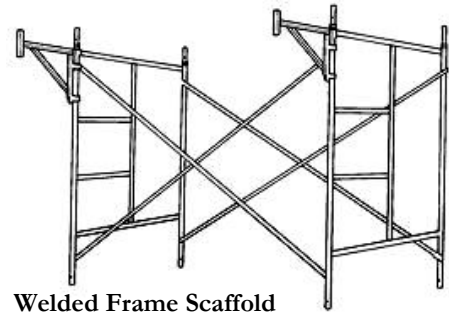

Welded Frame Scaffold

System Scaffold (Ring)

System scaffold is used where there are restrictions as to access into the build site or if obstacles like piping are in the way of a traditional set. It allows the competent person to build irregular sets such as rectangular shapes. It has various fixed lengths available and lifts are at 18" intervals. We primarily uses ring scaffold, but there are many other styles of system scaffold.

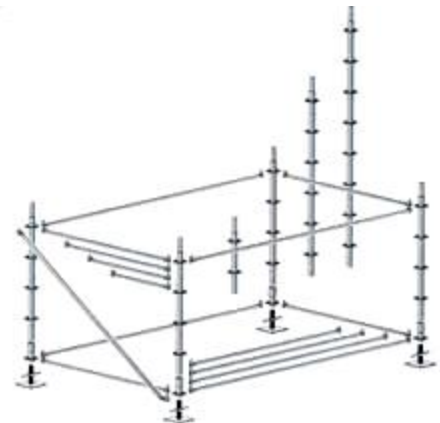

System Scaffold

Tube & Clamp Scaffolding

Like system scaffold, tube and clamp is a highly versatile scaffolding, but it requires a greater expertise to erect. It mimics what was done in the old days with lumber. It takes the longest to set because of all the clamps required to securely install the scaffold. This type of system is also know as twist lock.

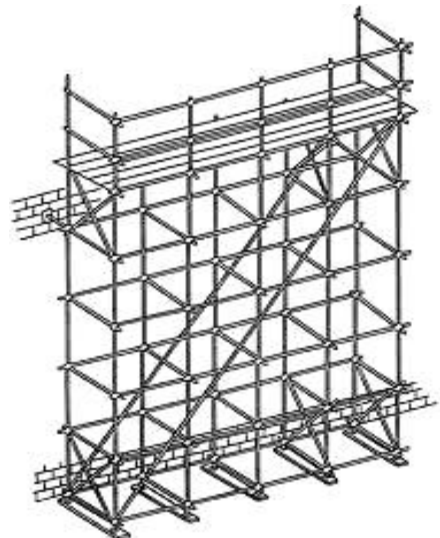

Tube & Clamp Scaffold

COMMONLY ASKED RULES OF SCAFFOLDING

- Towers can free stand at a height not to exceed four times your narrowest base dimension. (example a tower has a base of 5' x 7' then the tower can free stand $4 \times 5' = 20'$ tall).
- Ties for scaffold less than 3' wide start at 4 times the width and then every 20' vertically and every 30' horizontally. Scaffolds wider than 3' start at 4 times the width of the frame and then every 26' vertically and every 30' horizontally. More ties are required when enclosing scaffold with poly. (consult your sales rep for help).
- Guardrail/fall protection is required when the platform is at 10' (6' for residential construction) and the top rail must be between 38" to 45" above platform.
- Face guardrail is not required if the platform is within 14" of the face of the structure being worked on (18" for stucco, plaster and EIFS work).
- Guardrails must be able to with stand 200 lbs of applied force in a downward or horizontal direction at any point along the rail.— midrails 150 lbs.
- Toe boards are required on open ends when people are working underneath the scaffold. They must be able to withstand a 50lbs force.
- Spacing between platforms and supports cannot exceed $9 \frac{1}{2}"$, and no more than 1" between planks.
- Wood planks shall not be less than 6" from support point (unless cleated) and no more than 12" when overlapping to create a long platform. The minimum over lap must be 12" unless nailed together.
- Access to a platform 2' above or below any other platform shall be by portable ladders, integrated frame ladders, ramps, stairways, direct access from building or personnel hoist etc.
- When accessing with a ladder, the bottom rung cannot exceed 24", a rest platform must be provided every 35' and rungs spacing must be between 11.5" to 16.75". For an attachable ladder, the minimum rung width is 11.5" and for built-in frame ladders minimum width is 8".
- Access stairways bottom step can be a maximum 24" with a rest platform every 12' , step width minimum is 16".
- Stairways must be between 40 to 60 degree from horizontal.
- Ramps or walkways more than 6' above lower levels shall have guardrails and ramp shall not exceed 1 vertical to 3 horizontal units or 20 degrees above horizontal (exception are permissible, consult with your sales rep).
- Scaffolds must have a suitable base: base plate, casters and sills if ground is other than concrete or steel.
- Daily inspections prior to use are required. Inspection tags are available for purchase at our shop to hang from scaffold.
- Scaffold must not be within 10' of any power lines.

GENERAL REQUIREMENTS FOR ERECTION, USE AND DISMANTLE OF SUPPORTED SCAFFOLD

OSHA has mandated that a competent person must be present during erection and dismantle, inspect each day before use and during any alteration of original set. We are sanctioned by the SAIA to provide you with classes, testing and certificate of completion of the class so that your company can deem you as a competent person. Once at a project considerations always needs to be given from site to site as to the hazards, erecting, proper use, moving and dismantling of the scaffold.

Erecting

Proper planning is key to any project and the competent person needs to plan the erections of scaffold. The competent person can build scaffold up 125' without engineering, but once beyond that point engineers have to be involved to ensure proper loading will not be exceeded. Consideration has to be given to the base on which scaffold is to be set on, the height of the scaffold for tie in purposes and also such things as to how many levels will be decked. All these factors play into the stability of the over all set. All scaffolds need to be plumb, straight and components also checked to ensure they're in good condition before used in a set. Most of all the scaffold must be set in compliance of federal, state, local and personal company policies.

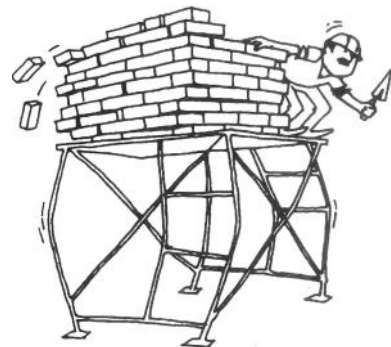

Use of Scaffolding

The scaffold is to be inspected by a competent person on a daily basis prior to each shift and corrective action must taken if issues are found. That person must also give authorization for any changes to a scaffold. Precautions must be taken when personnel are working on levels below the scaffold and also as to not to overload the scaffold which can cause failure. Never use cross braces to climb on for any reason. Never use scaffold as an anchorage for fall protection unless designed for that purpose along with manufactures authorization.

Dismantling

Prior to dismantling scaffold it should be inspected to ensure nothing has been altered especially wall ties. Since scaffold is dismantled from the top down if wall ties in the center where removed by someone else prior to dismantling and then you take off the ones at the top the scaffold the whole set would become unsafe or even worse collapse. When dismantling you are never to store dismantled items on the scaffold. All components should be lowered to the ground as they are removed.



GENERAL COMPONENTS OF SUPPORTED SCAFFOLDING FRAME & SYSTEM STYLES

In this section we will go over various components of supported scaffolding, from foundations to the accessories that will make your scaffold safe and functional. Depending from site to site, the competent person will choose the equipment that is best suited for their needs and a safe set up.

Foundation / Sills

The strength & stability of any scaffold set is dependent upon a good foundation. Many accidents occur due to a poor foundation. The competent person must understand the loads that are put on the foundations. Base plates, leveling jacks, or casters are required under all scaffold sets. In soil or rocky conditions mud sills may also be required to disburse the load of a set, even asphalt will need a sill. On average the point load can only be disbursed about 14" from the center point of the leg load but a sill should have at least 9" past the center point of the leg, and when possible use a sill that spans between both legs of a frame. The use of bricks or loose gravel to level out the legs is not acceptable. With the use of leveling jacks there is only a max of 18" of jack extending from the point of the frame to the end of the jack bottom, so when you use caster jacks the max on the screw is 12" to hit the max.

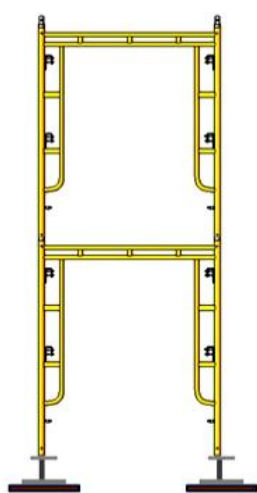

Fig 1: Small sills have a small load area and could sink if soil unstable

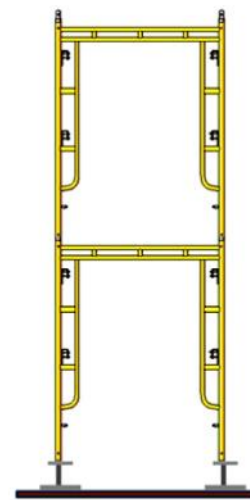
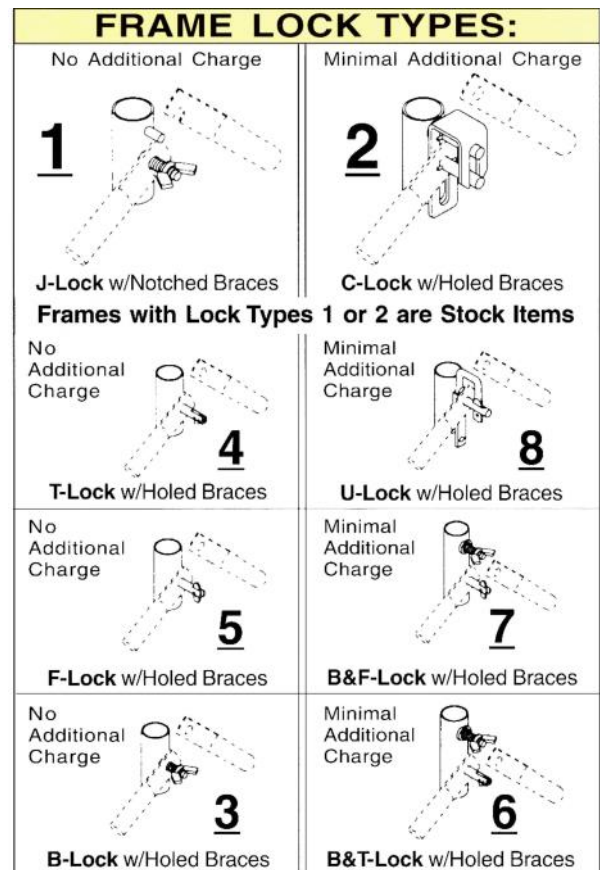
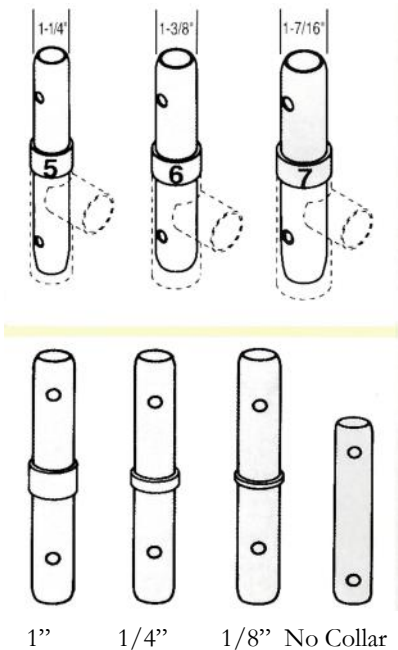
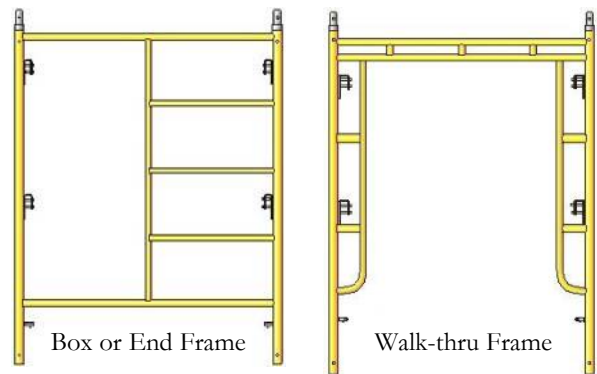
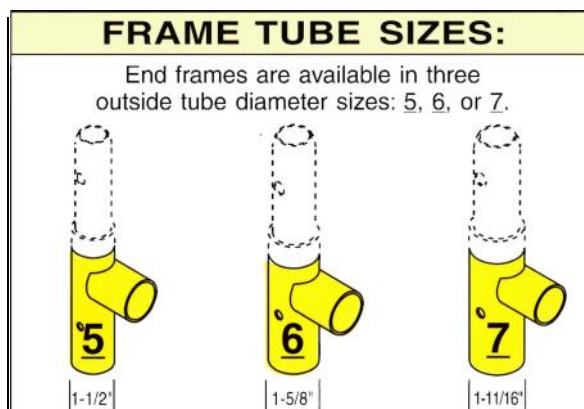
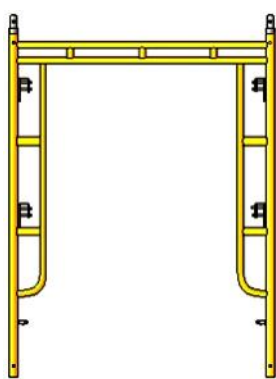

Fig 2: Large sills have a greater load area

Frames

Frames come in various sizes from 2' wide to standard 5' wide and also special canopy frames that are 6' wide to make pedestrian walkways. Widths of frames are measured from center of leg to center of leg so consideration must be given in tight places when ordering frames. A 24" wide frame actually measures a little over 25" and with the base plate or jacks, the over all outside dimension would be over 29". Frames come in two basic styles; box or end frames and also walk-thru style. They come in heights of 2' up to 6'7" and will stack to make any height desired for your platform. They also come in various tube diameters. We use a #7 tube with pins at a 45 degree angle. Our end frames come with a legal access ladder built into the frame so there is no need to rent a special bolt on ladder. Below are frame tube sizes, coupling pin size, collar types and last lock styles on frames.





Open or Walk-thru Frame

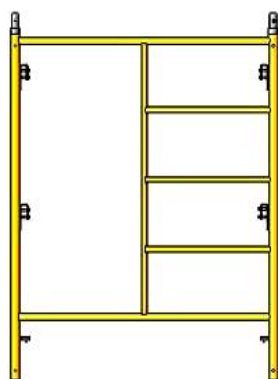

Box, Ladder or End Frame

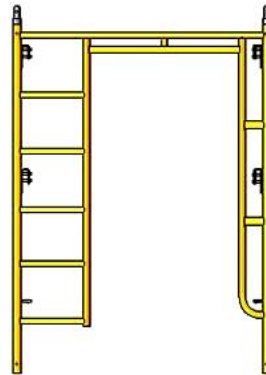

Combo or Mason Frame

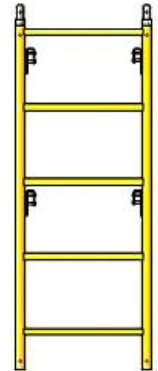

Narrow Frame

OUR RENTAL FRAMES

Part#	Type	Size	lbs	Brace Stud
F52	Ladder	5'WX2'H	26.0	1
F53	Ladder	5'WX3'H	29.5	2
F54	Ladder	5'WX4'H	36.5	3
F55	Ladder	5'WX5'H	38.0	4
F56	Ladder	5'WX6'4"H	44.0	4
FWT5	Walkthru	5'WX6'4"H	50.0	4
FWTL5	Combo	5'WX6'4"H	65.0	4
F33	Ladder	3'WX3'H	19.0	2
F35	Ladder	3'WX3'H	31.0	4
F36	Ladder	3'WX6'4"H	39.0	4
FWT3	Walkthru	3'WX6'4"H	39.0	4
F23	Ladder	2'WX3'H	16.5	2
F24	Ladder	2'WX4'H	21.0	3
F25	Ladder	2'WX5'H	25.5	4
F26	Ladder	2'WX6'4"H	33.5	4
CF	Canopy	6'WX7'6"H	60.0	4

Part#	Type	Size	lbs	Brace Stud
F42	Ladder	42"WX2'H	19.0	1
F43	Ladder	42"WX3'H	23.0	2
F44	Ladder	42"WX4'H	35.4	3
F45	Ladder	42"WX5'H	37.0	4
F46	Ladder	42"WX6'4"H	42.5	4
FWT4	Walk thru	42"WX6'4"H	43.0	4

Part#	Type	Size	lbs	Brace Stud
WR52	Waco	5'WX2'1"H	24.0	1
WR53	Waco	5'WX3'1"H	32.0	2
WR54	Waco	5'WX4'1"H	35.0	3
WR55	Waco	5'WX5'1"H	40.0	4
WR56	Waco	5'WX6'7"H	48.2	4
WRFWT	Waco	5'WX6'7"H	56.4	4
WRFWTL	Waco	5'WX6'7"H	56.5	4

***Many other frame styles & sizes available for purchase & special order**

Due to the mass differences in types in style of scaffolding, we can only stock and rent just so many. Scaffolding can be special ordered to the same specs as what you may currently have in your inventory. They can also come ordered in other materials like aluminum or even fiberglass. Your Scaffold rep is committed to helping you get what you need or want for your inventory so call them today.

Bracing

Bracing is a vital part of the strength and integrity of scaffolding. Bracing includes cross braces, horizontal brace, diagonal brace for frame scaffold. Its also bay brace and ledgers for system scaffold (covered later). Wall ties for right angle bracing for both. All vertical members must be braced at regular intervals. A common “don’t” that happens in the field is using cross braces to climb up scaffold, THIS IS NOT ALLOWED. Bracing is required every 6’6” on the plan of the face of the scaffold. Bracing for frame scaffold is required on both face sides but not the transverse since it is built into the frame. For system or fast tube, no more than three un-braced bays between each bay braced section. The Braces should always be in at wall tie points for system & fast-tube.

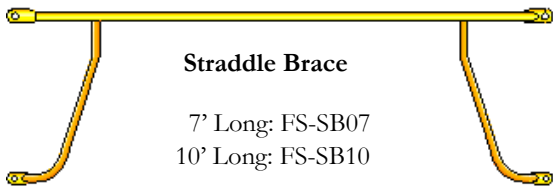
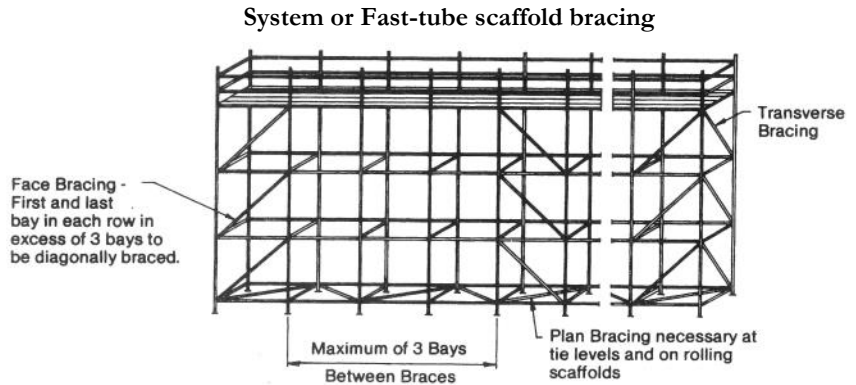
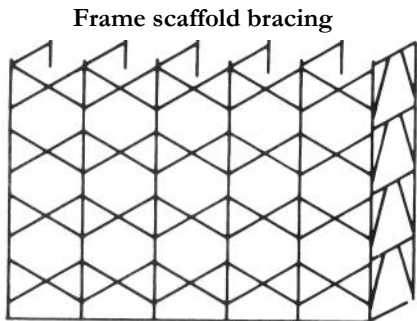

Diagonal Brace (Rolling Towers)
7' Long: DB75
10' Long: DB105

Horizontal Brace
7' Long: HB07
10' Long: HB10

We rents tubular braces, but angle iron braces are available to special order for purchase. The brace length is determined by the plank size used. Keep in mind when wood scaffold grade planks are used, the plank must overhang a minimum of 6” and a maximum of 12” so choose a brace smaller than the wood plank size.

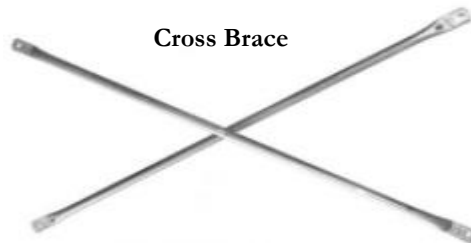

Stud Space	SPACE BETWEEN FRAMES											
	4'0"		5'0"		6'0"		7'0"		8'0"		10'0"	
1'0"	B41	49 1/2"	B51	61 1/4"	B61	73"	B71	84 7/8"	B81	96 3/4"	B101	120 1/2"
2'0"	B42	53 7/8"	B52	64 5/8"	B62	75 7/8"	B72	88 7/8"	B82	99"	B102	122 3/8"
3'0"	B43	60"	B53	70"	B63	80 1/2"	B73	91 3/8"	B83	102 1/2"	B103	125 1/4"
4'0"	B44	67 7/8"	B54	76 7/8"	B64	86 1/2"	B74	96 3/4"	B84	107 1/4"	B104	129 1/4"

Ties

Ties are essential for the strength and safety when scaffold exceeds the 4:1 height to base ratio. Ties keep the scaffold plumb and secure it from tipping in towards the surface (compression) or pulling away from the surface (tension). This can occur due to wind loads or over loading an area. Old school is to use 2x4 studs for compression and number 9 tie wire for tension. We use anchor I-bolts with a system ledger to accomplish both compression & tension.

GENERAL RULES TO FOLLOW:

- 1) All ties should be attached with load bearing clamps
- 2) The entire scaffold should be tied using the follow schedule; for scaffold less than 3' wide start at 4 times the width and then every 20' vertically and every 30' horizontally as well as both ends. Scaffolds wider than 3' start at 4 times the width of the frame and then every 26' vertically and every 30' horizontally as well as both ends. More ties are required when enclosing scaffold with poly. (consult your sales rep for help)

COMMON TYPES OF TIES:

- 1) Through Ties; where a tube is taken through any opening like a window and tightly clamped inside and outside the opening to create a positive tie. (Fig A)
- 2) Box Ties; in which tubes are used to go around columns (Fig B)
- 3) Anchor bolt ties; (most commonly used) in which I-bolt anchors are put into a structure or mortar joints to create a connecting point. The anchorage point most have a pull out force of 800 lbs for lite, 1200 lbs for medium or 1600 lbs for heavy duty scaffolds. This will require patching of holes after the anchors are removed. (Fig C)
- 4) Tube to beam ties; which you use a pair of beam clamps to secure the tube to a steel I-beam and then back to the scaffold. (Fig D)

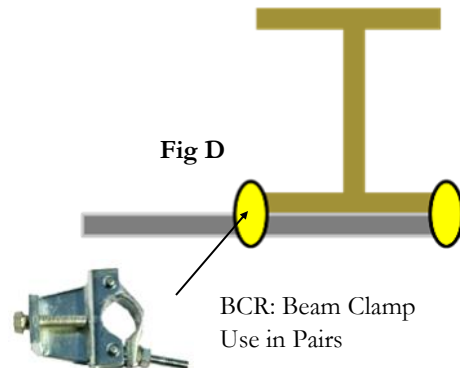
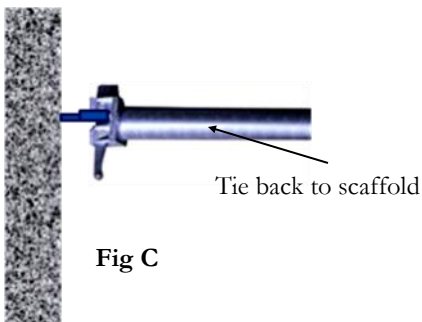
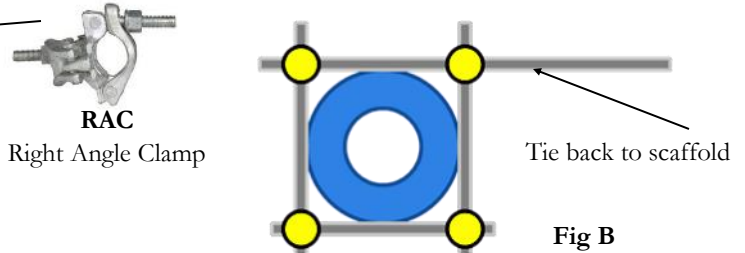
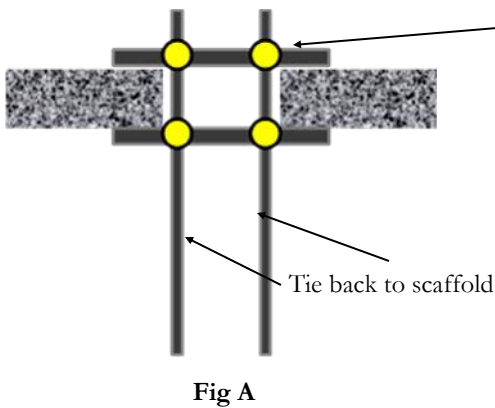

Planking

Scaffold planking comes in many different styles including wood, steel, and aluminum planks. Like any other scaffolding components they should be inspected prior to use and select the right plank for the right job. Hook planks can be all aluminum or aluminum sides with a ply top deck. Planks have a rating of pound per square foot (psf). For example a 7' plank 19" wide would have an evenly distributed weight capacity of 831 pounds (1.58'x7'x75psf). Stay within the recommended loads to avoid collapse. Aluminum planks and steel planks can come with one of two hook types A or 1 which is 7/16 from top of scaffold to top of the plank and hook type B or 2 is 1 5/16 (Fig A). Type 2 hooks are used so that if you use a wood plank next to it to fill in gaps there is no tripping hazard. Wood planks can be either solid sawn (requires OSHA stamp) or laminated veneer lumber "LVL" and come in various widths.

Fig A

Type 1 or A



Type 2 or B



Part#	Size	lbs
WAP-0400	19"X4'	18.5
WAP-0500	19"X5'	22.8
WAP-0504	19"x5'4"	27.4
WAP-0600	19"X6'	28.0
WAP-0700	19"X7'	32.0
WAP-0800	19"X8'	36.5
WAP-1000	19"X10'	49.5

Part#	Size	lbs
AAP-0400	19"X4'	18.5
AAP-0500	19"X5'	22.0
AAP-0600	19"X6'	26.3
AAP-0700	19"X7'	28.9
AAP-0800	19"X8'	32.0
AAP-1000*	19"X10'	39.3

Part#	Size	Lbs
AAP-H-0400	9.5"X4'	9.3
AAP-H-0500	9.5"X5'	12.0
AAP-H-0600	9.5"X6'	13.2
AAP-H-0700	9.5"X7'	16.0
AAP-H-0800	9.5"X8'	16.2
AAP-H-1000	9.5"X10'	26

Part#	Size	lbs
SP-0300	9"X3'	15.7
SP-0306	9"X3'6"	17.1
SP-0400	9"X4'	19.0
SP-0500	9"X5'	23.2
SP-0600	9"X6'	26.5
SP-0700	9"X7'	31.2
SP-0800	9"X8'	35.4
SP-0806	9"X8'6"	37.0
SP-1000	9"X10'	42.9

Part#	Size	lbs
WP4	4' Lam plank	14.5
WP6	6' Lam plank	25.2
WP8	8' Lam plank	29.4
WP9	9' Lam plank	33.0
WP10	10' Lam plank	36.0
WP12	12' Lam plank	50.4
WP16	16' Lam plank	58.8

Alum w/Ply top 75psf



All Aluminum 75psf

*10' is 50psf



All Aluminum 1/2 Plank



Steel Pan Plank 75psf



Wood Plank

10' span 25psf

8' span 50psf

6' span 75psf

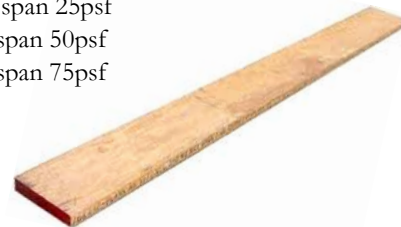

CAUTION

Debris and rubble should never be allowed to accumulate on planking.

In winter conditions always keep planks free of snow and ice buildup.

On high scaffolds extra care should be taken for wind effects. All planks up high should be tie wired down or plank restraining clip used.

**Other sizes and styles of planks are available for order just call your rep to get pricing and availability

Wood Planking Special Requirements

Unlike standard hook planks that are made to fit the exact length of a frame set, wood planks have special rules that must be followed to avoid failure or fines for improper use. Most wood plank are nominal 2" x 10" and must contain a stamp stating "SCAFFOLD GRADE". Wood planks are required to extend a minimum of 6" beyond the center bearing point of the scaffold (unless cleated to prevent movement) and no more than 12" (Fig B). Inspection of the planks should be done prior to each use. Your rep should be able to provide you with a guide to inspect wood boards and for testing deflection. Figure C shows some of the thing to look for during inspection.

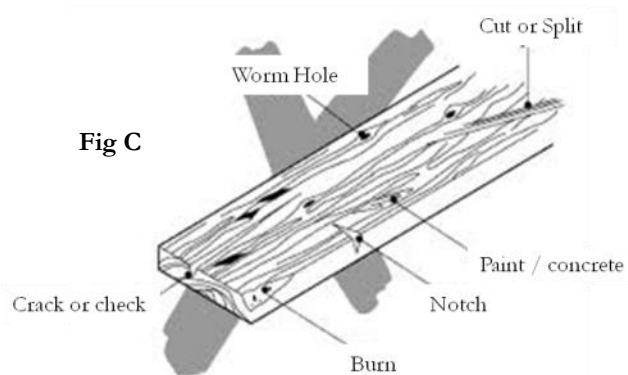
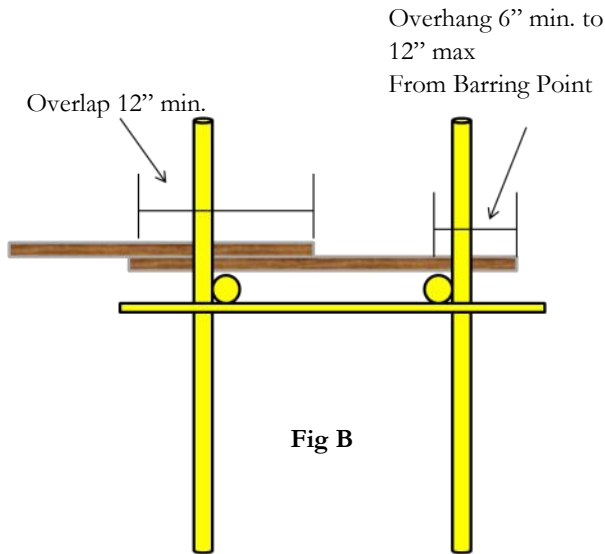

Possible defective items on a solid sawn wood or microlam planks

Large Plank



FS-SPS
Plank Spigot



Part#	Size	Lbs
AXP1408	14" X 8-13'	43.0
AXP1410	14" X 10-17'	53.0



Part#	Size	Lbs
PICK-1214	14" X 12'	38.0
PICK-1224	24" X 12'	71.0
PICK-1614	14" X 16'	56.0
PICK-1624	24" X 16'	80.0
PICK-2014	14" X 20'	81.0
PICK-2024	24" X 20'	111.0
PICK-2414	14" X 24'	96.0
PICK-2424	24" X 24'	133.0
PICK-2824	24" X 28'	188.0
PICK-3224	24" X 32'	182.0

*Use with your regular frame guardrail post and guardrails

Other sizes and styles of planks are available for order just call your rep to get pricing and availability.

Loads

The maximum load capacity of any scaffold is determined by the maximum load of the various components and by making sure you stay within those limits. A frame header can support 2,300 lbs on a 4' wide frame which can hold 2 hook planks, this doesn't mean you can load the planks with the 2,300 lbs. Both planks together can only support 1,632 lbs evenly distributed. You must also consider leg loads when building tall structures. OSHA requires a 4:1 safety factor to be used when designing scaffold. This safety fact is used in computing the load capacity of all the scaffold components that will have people working on them (material handling components are typically 2:1). In order to compute the load being applied, one must determine its

Definition of live loads

- Lite Duty: 25 lbs per square foot.
(Painting & Window cleaning)
- Medium Duty: 50 lbs per square foot.
(Plastering & Stucco)
- Heavy Duty: 75 lbs per square foot
(Mason, Stone setter & other heavy load contractors)

LOAD CHART FOR FRAMES *

Part#	Type	Tier 1	Tier 2	Tier 3	Tier 4
F53	3'H X 5W	4,200	3,465	3,360	2,993
F54	4'H X 5W	4,200	3,465	3,360	2,993
F55	5'H X 5W	4,043	3,360	3,213	2,835
F56	6'4"H X 5W	2,441	2,240	2,048	1,785
FWTL5	Walkthru	3,434	3,045	2,646	2,373

For towers in excess of 4 tiers high, subtract dead load weight/leg of frames, crossbraces, & brackets above fourth tier to obtain an allowable load/leg for workman, material and planking. All values are based upon a maximum of 12" extension on the leveling jacks

* *The load chart above is for quick reference purposes only on what leg loads typically are, but they will differ a little from manufacturer to manufacturer and also based on tube size. Extreme caution should be used in trying to calculate leg loads for large sets. We strongly recommend that you consult your rep or an engineer for proper calculations to avoid any failures or overloading your scaffold.*

Guardrail & Toeboards

When any work platform is above 10' in height (6' for residential) guardrail & midrails are required. The height of the top rail should be between 38"-45" above the platform and the midrails should be midway between the top rail and platform. Guardrail can be omitted on the work surface side if the tower is no more than 14" from the surface (18" for stucco, plaster or EIFS). Top guardrails must be able to withstand a force without fail of 200 lbs applied in any downward or horizontal direction at any point on the guardrail. Midrails must withstand a force of 150 lbs. Toe boards are required on any open side in which there are people working below that platform. They need to be at least 3.5" tall and be able to withstand a 50 lbs of force.

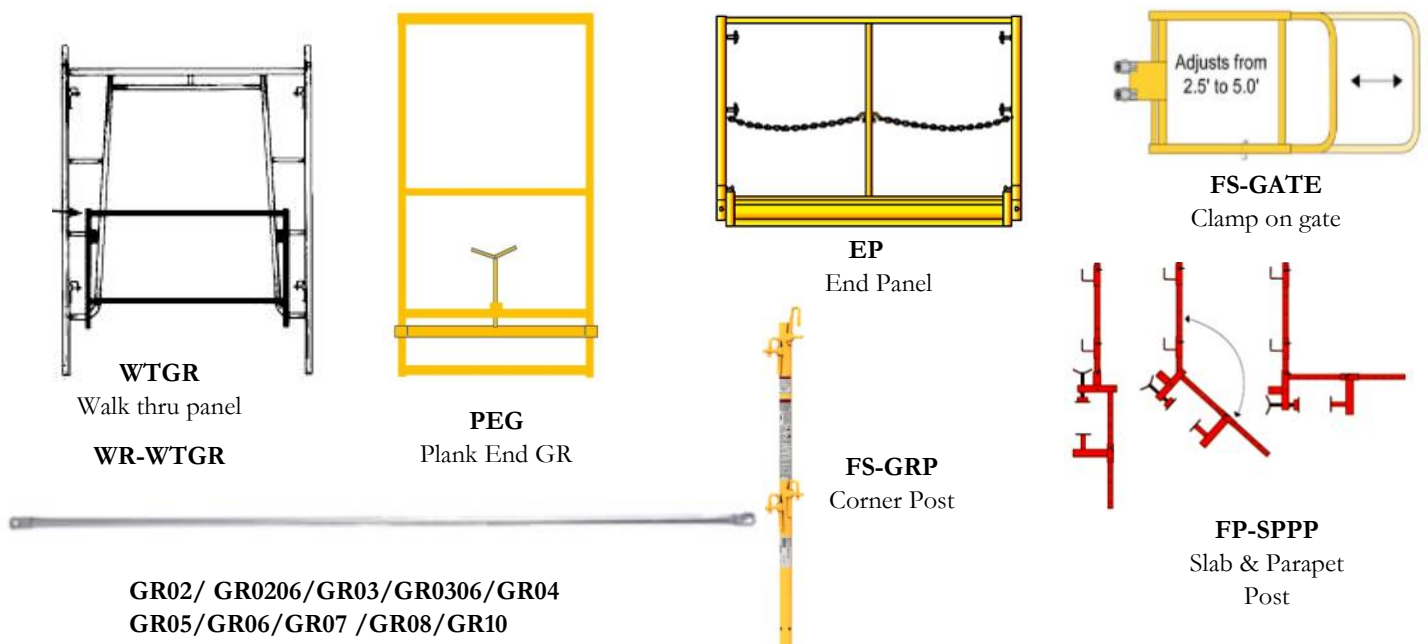

Enclosures for Scaffold

When enclosing scaffold in poly the tie schedule should be increased because with poly, the wind forces on the scaffold are extreme, even in winds of 30 miles per hour. Thus, the tie schedule should be a minimum of every 13' vertically and 14' horizontally. The anchor points must also be able to withstand a pull force of 1500 lbs. This tie schedule is based on scaffold with a height max of 60' and winds not exceeding 30 mph. Anything greater than these numbers one should consult an engineer for a proper tie schedule and anchorage pull force.

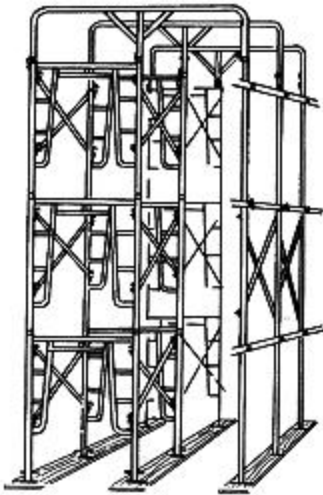

Part#	Description	lbs
BWET	Top	28

Leg

BWEL10	10' -18' Adj. Leg	31
--------	-------------------	----

Extension Leg

BWEXT10	10' Ext Leg	14
BWEXT5	5' Ext Leg	7

We also stocks various size poly along with wind clips for both frame and system scaffold

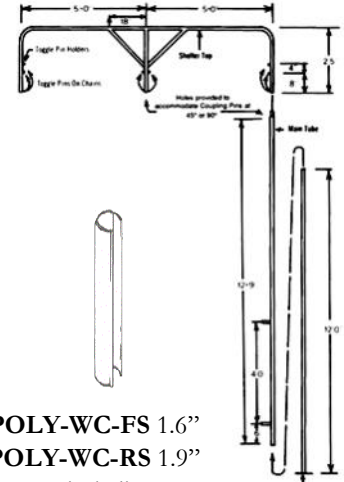

POLY-WC-FS 1.6"
POLY-WC-RS 1.9"
Wind clip



Mesh Netting

- Come in various colors
- 30%- 90% Shading
- Height 4'-10' x 150'



Debris Netting

- Come in various colors
- Knitted or 1/8 to 1/4" square
- Height 4'-12' x 150'



Poly - Geotarps - Airbags

Side arms & End arms

When scaffold cannot be built close to a structure or if its just for the ease of moving a work platform side arms and or end arms are a great accessory. They are for personnel only not material. Most side arms are rated for only 250 lbs. They can come rigid or adjustable.

Part#	Description	lbs
FS-SA-A-30	20-30" Adj. Side Arm	14.0
FS-SA-A-48	30-48" Adj. Side Arm	24.0
FS-SA-10	10" Side Arm	8.0
EBA	20-30" Adj. End Arm	14.0

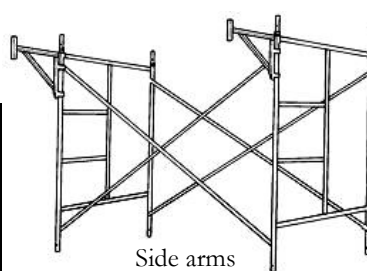

Side arms

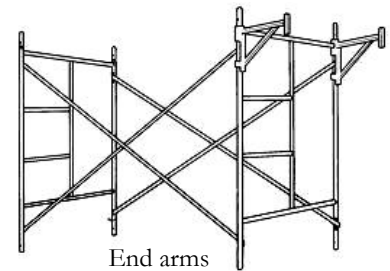

End arms

Guardrail

FS-SA-GR-30	GR of adj. 20-30"	15.0
FS-SA-GR-48	GR of adj. 30-48"	19.0

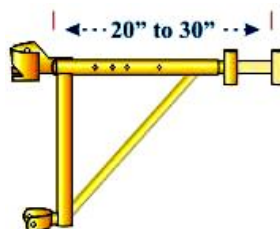

FS-SA-A-30
20-30" side

FS-SA-A-48
30-48" side

EBA
20-30" end

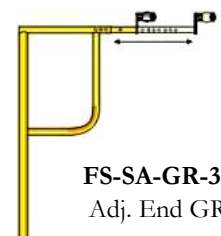

FS-SA-GR-30
Adj. End GR

Quick Frame & Brace Count Chart

The chart below can be used to determine how many frames and braces you would need to cover a certain height and length. You choose what size frame you want to use on the left and then choose what size plank. Next determine the height and length you want to achieve and where the two intersect is what you would need for frames and braces. Your rep with us can also help you in figuring all your equipment needs.

ESTIMATING CHART					Length based on 6' 7' 8' or 10' spacing between frames																						
No. High	Total Height			Qty Used	10	20	30	40	50	60	70	80	90	100	110	120	130	140	150	160	170	180	190	200	210	220	230
	4'	5'	6'4"		8	16	24	32	40	48	56	64	72	80	88	96	104	112	120	128	136	144	152	160	168	176	184
					7	14	21	28	35	42	49	56	63	70	77	84	91	98	105	112	119	126	133	140	147	154	161
1	4'0"	5'0"	6'4"	Frame	2	3	4	5	6	7	8	9	10	11	12	13	14	15	16	17	18	19	20	21	22	23	24
				Brace	2	4	6	8	10	12	14	16	18	20	22	24	26	28	30	32	34	36	38	40	42	44	46
2	8'1"	10'1"	12'9"	Frame	4	6	8	10	12	14	16	18	20	22	24	26	28	30	32	34	36	38	40	42	44	46	48
				Brace	4	8	12	16	20	24	28	32	36	40	44	48	52	56	60	64	68	72	76	80	84	88	92
3	12'2"	15'2"	19'2"	Frame	6	9	12	15	18	21	24	27	30	33	36	39	42	45	48	51	54	57	60	63	66	69	72
				Brace	6	12	18	24	30	36	42	48	54	60	66	72	78	84	90	96	102	108	114	120	126	132	138
4	16'3"	20'3"	25'7"	Frame	8	12	16	20	24	28	32	36	40	44	48	52	56	60	64	68	72	76	80	84	88	92	96
				Brace	8	16	24	32	40	48	56	64	72	80	88	96	104	112	120	128	136	144	152	160	168	176	184
5	20'4"	25'4"	32'0"	Frame	10	15	20	25	30	35	40	45	50	55	60	65	70	75	80	85	90	95	100	105	110	115	120
				Brace	10	20	30	40	50	60	70	80	90	100	110	120	130	140	150	160	170	180	190	200	210	220	230
6	24'5"	30'5"	38'5"	Frame	12	18	24	30	36	42	48	54	60	66	72	78	84	90	96	102	108	114	120	126	132	138	144
				Brace	12	24	36	48	60	72	84	96	108	120	132	144	156	168	180	192	204	216	228	240	252	264	276
7	28'6"	35'6"	44'10"	Frame	14	21	28	35	42	49	56	63	70	77	84	91	98	105	112	119	126	133	140	147	154	161	168
				Brace	14	28	42	56	70	84	98	112	126	140	154	168	182	196	210	224	238	252	266	280	294	308	322
8	32'7"	40'7"	51'3"	Frame	16	24	32	40	48	56	64	72	80	88	96	104	112	120	128	136	144	152	160	168	176	184	192
				Brace	16	32	48	64	80	96	112	128	144	160	176	192	208	224	240	256	272	288	304	320	336	352	368
9	36'8"	45'8"	57'8"	Frame	18	27	36	45	54	63	72	81	90	99	108	117	126	135	144	153	162	171	180	189	198	207	216
				Brace	18	36	54	72	90	108	126	144	162	180	198	216	234	252	270	288	306	324	342	360	378	396	414
10	40'9"	50'9"	64'1"	Frame	20	30	40	50	60	70	80	90	100	110	120	130	140	150	160	170	180	190	200	210	220	230	240
				Brace	20	40	60	80	100	120	140	160	180	200	220	240	260	280	300	320	340	360	380	400	420	440	460
11	44'10"	55'10"	70'6"	Frame	22	33	44	55	66	77	88	99	110	121	132	143	154	165	176	187	198	209	220	231	242	253	264
				Brace	22	44	66	88	110	132	154	176	198	220	242	264	286	308	330	352	374	396	418	440	462	484	506
12	48'11"	60'11"	76'11"	Frame	24	36	48	60	72	84	96	108	120	132	144	156	168	180	192	204	216	228	240	252	264	276	288
				Brace	24	48	72	96	120	144	168	192	216	240	264	288	312	336	360	384	408	432	456	480	504	528	552
13	53'0"	66'0"	83'4"	Frame	26	39	52	65	78	91	104	117	130	143	156	169	182	195	208	221	234	247	260	273	286	299	312
				Brace	26	52	78	104	130	156	182	208	234	260	286	312	338	364	390	416	442	468	494	520	546	572	598
14	57'1"	71'1"	89'9"	Frame	28	42	56	70	84	98	112	126	140	154	168	182	196	210	224	238	252	266	280	294	308	322	336
				Brace	28	56	84	112	140	168	196	224	252	280	308	336	364	392	420	448	476	504	532	560	588	616	644
15	61'2"	76'2"	96'2"	Frame	30	45	60	75	90	105	120	135	150	165	180	195	210	225	240	255	270	285	300	315	330	345	360
				Brace	30	60	90	120	150	180	210	240	270	300	330	360	390	420	450	480	510	540	570	600	630	660	690

Frame Brace Locks and Safety Pins

There are many styles of brace locks on welded frames. Below in (Fig A) shows the various types and how we refer to each type. We use the “T” locks which allows the builder to attach the brace without standing next to the frame. OSHA requires a safety pin at any junction where two pieces of scaffold come together and where uplift may occur. Most frames will have coupling pins inserted on top of the scaffold held in place with a semi permanent pin, spring rivet or rivet cotter pin (Fig B). The spring rivet is the most commonly used on frames today. When scaffold is stacked temporarily, pins are used, see (Fig C).

FIG A

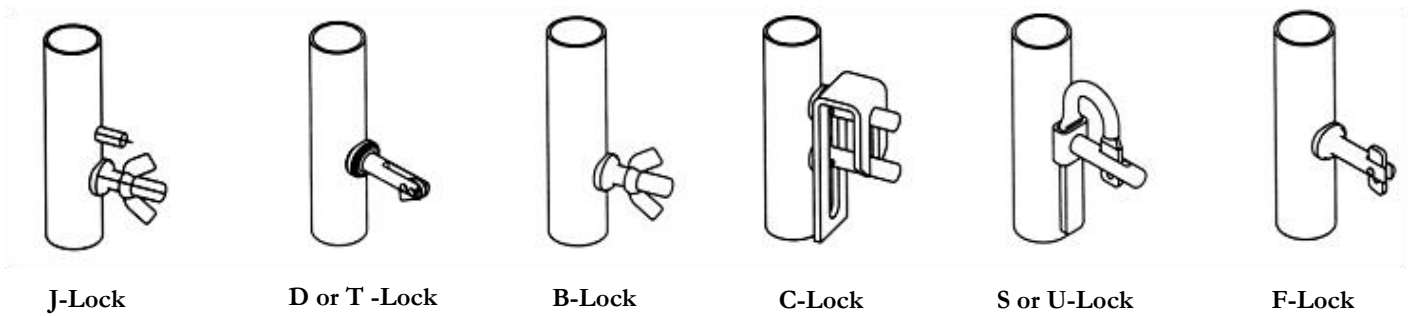

FIG B



SR
Spring Rivet



LP & HP
Cotter & Hair Pin

Caution

Caution must be taken anytime scaffold is to be moved by craning or forklifts. If this is attempted you need to replace all (semi permanent & temporary locks) intersecting points with grade 5 bolts. To avoid separation during transporting to new location.

FIG C



FS-PT
Pigtail



TP
Toggle Pin



HARD-SP2
Snap Pin

Snap pins and toggle pins come in various lengths the 2” is most common in both. So if you require a special size make sure to specify when placing orders with your rep

Other Miscellaneous Components

There are hundreds of components for welded frame scaffold...too many to discuss but below are other items We rent and sell to make your job easier and safer.



OR
Outrigger

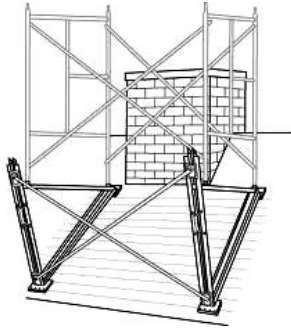

CB
Chimney Bracket
2:12 TO 12:12 Pitch



FS-S-ASW5/FS-S-ASW6
FS-S-AOHR5/FS-S-AOHR6
FS-S-AIHR
Alum 24" Stairs with rails



FSSB
Stairway Starter Bar

Part#	Size	Lbs
T04-L	4'	9.2
T06-L	6'	13.3
T08-L	8'	19.0
T10-L	10'	23.0
T13-L	13'	34.0
T16-L	16'	41.5
T20-L	20'	51.0



Twist Lock
GILCO



BP-L
Gilco Base Plate



BCS
Swivel Beam Clamp



BRC
Rigid Beam Clamp



FS-GRC
G/R Clamp



PLSF5
Putlog Spreader



SH-SH
Shore head



SWC
Swivel Clamp



RAC
Right Angle Clamp



FS-BSSFF
Side by Side



PLOS
Putlog Offset



PL12
Putlog 12'



PL16
Putlog 16'

PL22
Putlog 22'

PL26
Putlog 26'

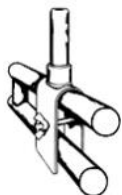

PLCB
Curved Base Plate



PLH
Putlog Hanger



PLSH
S Hanger



FS-COS
Frame Clamp on Spigot



WW
Well Wheel

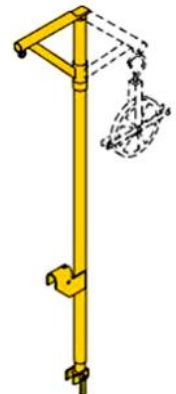

HA
Hoist Arm

System Scaffold (RING)

System scaffold come in 3 basic types cup lock, ring, and kwik/wedge lock. System scaffold is one of the most versatile scaffold there is today along with the speed and ease to set up and dismantle. Here we carry ring style in various sizes with many sizes available to order for sale. It also has very little chance for errors do to the positive locking system which it makes it safe. This section will concentrate on ring scaffold only, but we can special order for sale the other styles if you need to match your existing inventory.

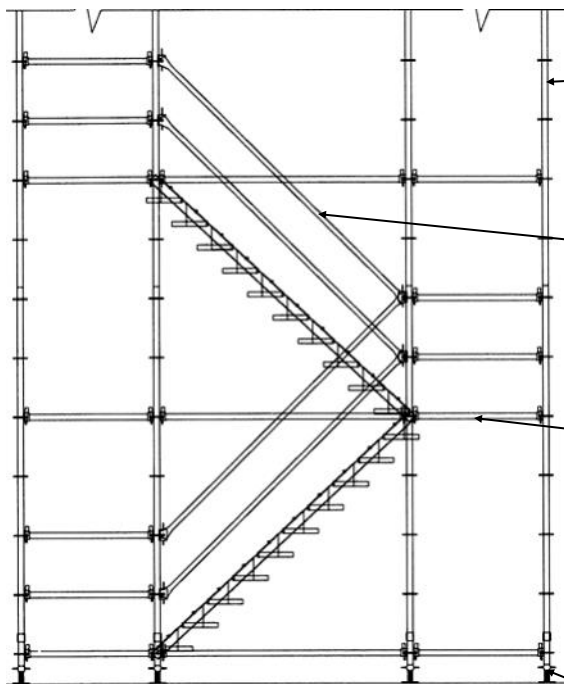

Vertical Standards: Vertical come in various heights and have rings to attach ledgers about every 19.5". This allows for platforms to be added at various heights

Bay Braces: These braces are used to square up the set along with being used for handles when stairs are installed.

Horizontal Ledgers: Ledgers are used to tie the verticals together to form boxes or even circles. They are also used as guard-rails. They can be used as load barring only if they are less than 5'. A maximum of 6'7" in height between ledgers or every fourth rosette.

Truss Ledgers: Ledgers are used for load barring the planks when the span between verticals exceeds 5.5'

Base Collar & Leveling Jacks

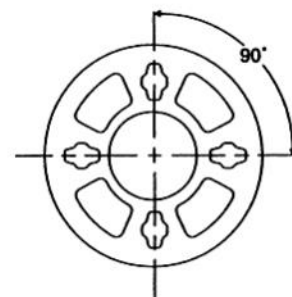
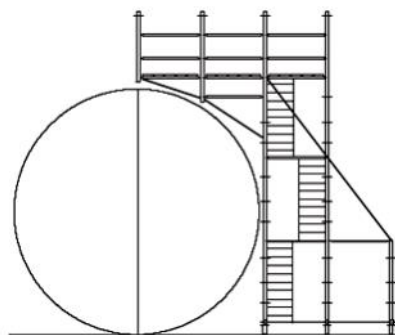
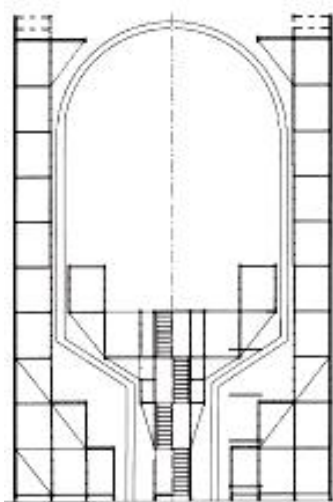

Overhead view of system ring or rosette. There are four slots used to make a perfect rectangle. The larger holes are used when making shapes other than a box and for bay braces.

Basic Set Up Procedure For System Scaffold

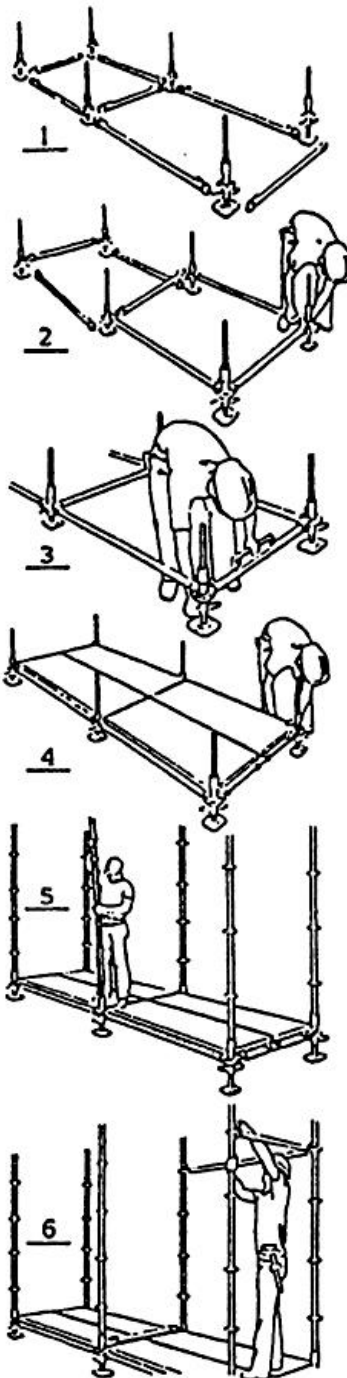

1. Fit adjustable bases with collars and lay out roughly in position with their corresponding ledgers. Pick the highest ground level for a setting out point to simplify later adjustment. It helps if the screw jack is near (not at) the bottom of the thread by allowing maximum adjustment on lower ground levels.
2. Connect the ledgers to the rosette on the collar of the adjustable base. **DO NOT DRIVE HOME THE WEDGES AT THIS STAGE.**
3. Using a spirit level, adjust the bases so that the ledgers are horizontal. Accuracy in leveling at this stage eliminates the need for further leveling and plumbing as the scaffolding is erected.
4. Place two aluminum planks or four 255mm (10") wide board in each bay spanning the ledgers to square up the system. Move progressively round the base of the scaffolding. When squared and leveled drive home the wedges.
5. When basing out is completed, the first standards are positioned into the collar of the base.
6. Ledgers can now be placed at the required levels.
7. Handrails is automatically positioned.
8. Planks are now moved up to this first lift, decking out fully if this is to be a working platform.
9. Fix diagonal braces across the face of the bays. Hammer wedges home.
10. The scaffolding is completed by adding ledger midrails, handrails and toe boards on the working platform.

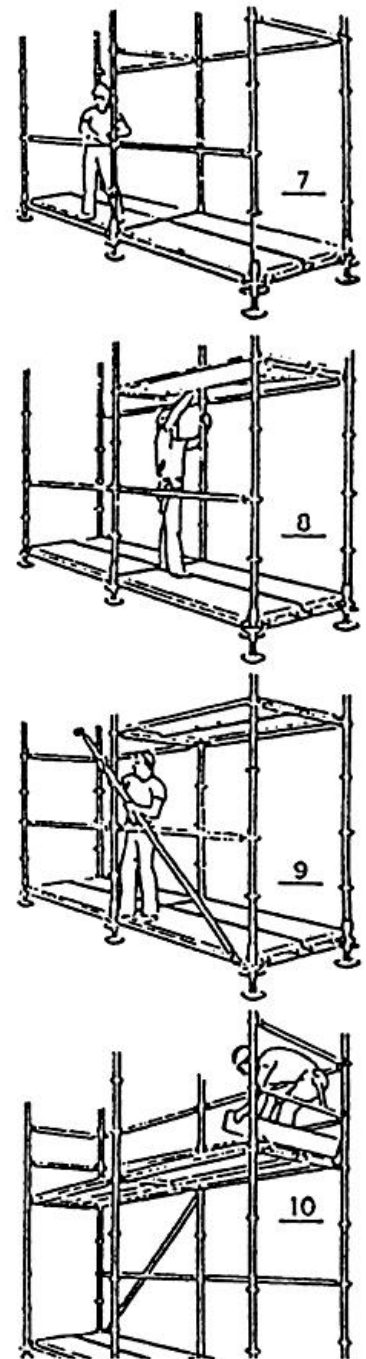

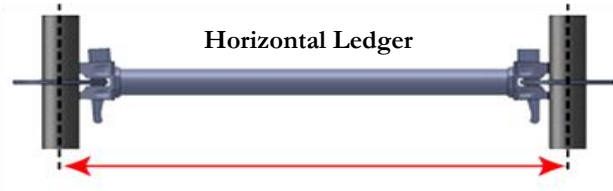
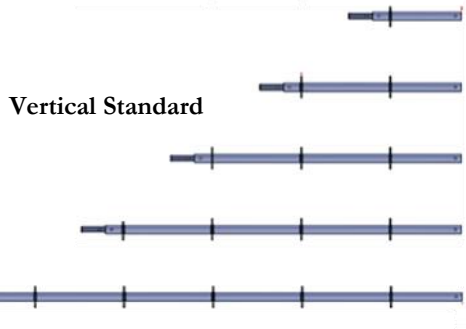

Ledger listed length center to center of vertical
Actual length is about 2" less listed (SL-0200 is about 22")
Actual usable bar space is about 5.5" less than listed

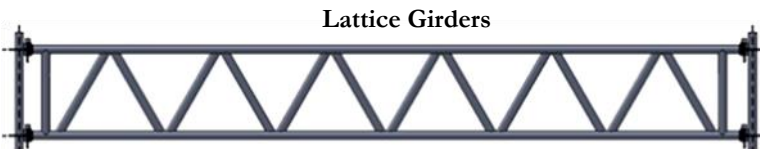
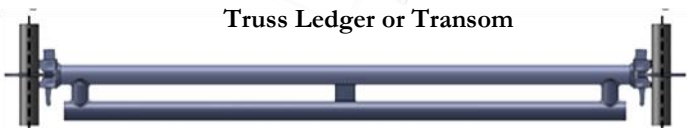

Other sizes are available for special sales orders
 contact your local rep to get pricing.

Vertical Standard

Part#	Height	lbs
V-1	18"	6.9
VS-2	3'3"	12.1
VS-3	4'11"	17.3
VS-4	6'7"	25.2
VS-5	8' 2"	29.0
VS-6	9'10"	32.9

Horizontal Ledger

Bay Brace

Part#	Length	lbs	Part#
SL-0104	1'4"	5.7	NA
SL-0200	2'0"	7.0	NA
SL-0202	2'2"	7.1	NA
SL-0206	2'6"	8.2	NA
SL-0210	2'10"	7.7	NA
SL-0300	3'0"	9.4	BB-0300
SL-0306	3'6"	10.3	BB-0306
SL-0307	3'7"	10.4	BB-0307
SL-0310	3'10"	11.7	BB-0310
SL-0400	4'0"	11.9	BB-0400
SL-0403	4'3"	12.0	BB-0403
SL-0500	5'0"	14.8	BB-0500
SL-0504	5'4"	15.0	BB-0504
SL-0600	6'0"	16.2	BB-0600
SL-0700	7'0"	18.7	BB-0700
SL-0800	8'0"	21.6	BB-0800
SL-1000	10'0"	26.7	BB-1000

Truss Ledgers

Part#	Length	lbs
TL-0600	6'	30.0
TL-0700	7'	34.4
TL-0800	8'	40.7
TL-1000	10'	51.7

Lattice Girders

Part#	Length	lbs
LG-0700	7'	50
LG-1000	10'	75
LG-1200	12'	85
LG-1400	14'	103
LG-1700	17'	130
LG-2000	20'	143
LG-2100	21'	160
LG-2300	23'	174
LG-2400	24'	182
LG-2800	28'	219

Other System Components

There are hundreds of components for system scaffold...too many to discuss but below are other items We rent and sell to make your job easier.



RS-WMR
Wall Mount



MC
Mullen Clamp



COR
Rosette Clamp



RAC-S
Right Ang Clamp



SWC-S
Swivel Clamp



RS-COS
Clamp On Spigot

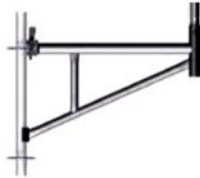

SB-0104, SB-0200, SB-0202
SB-0211, SB-0300, SB0310
Side Bracket



SSB 44"
SSB-ETO 36"
Wire Basket Rack



SSR 44"
SSR-ETO 36"
Rack



SC
Starter Collar



AL-03 /AL-06
Ladders

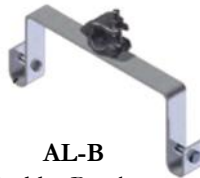

AL-B
Ladder Bracket



RS-S-36 3'6" High
RS-S-7 7' High
Stair Stringer



RS-T-32
32" Stair



RS-CPSP
Frame to System
Spigot



FS1500
5' Boiler Ladder



FS3000
10' Boiler Ladder



BOILER-TB
Throat Bracket



BOILER -FB-A-10
10' Alum Foundry
Beam



CR-12-HD
CR-12-ADJ
System Caster
Adjustable & Non Adj



DA
Davit Arm



RS-GATE
Safety Gate



RS-DWC
Double Wedge Clamp



RS-LA
Lock Arm

BASIC TEMPORARY SUSPENDED SCAFFOLD TYPES

There are three basic types of suspended scaffolds available for use in the construction industry. Again this is just a general overview of common types, but many more are available for sale just contact your rep.

Swing Stage (Two Point Suspension)

A swing stage has a two or more point suspension. They can be made with standard fixed length aluminum pick boards, modular decks or knock down decking.

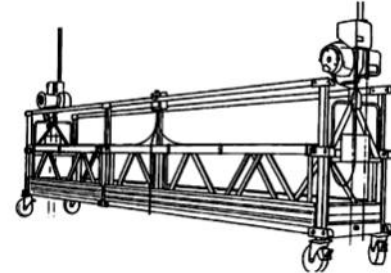

Work Cage (Single Point)

Work Gages are a single point suspended scaffold. Typically for one man, but in some cases wings can be added to make it a two man basket.

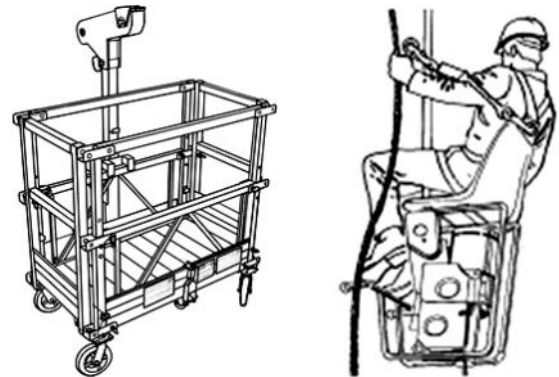

Bosun Chair (Single Point)

Bosun chairs are another single point suspended scaffold. This is only for one person and is used for window washing, repairs or just to get into tight spaces.

GENERAL REQUIREMENTS FOR ERECTION, USE AND DISMANTLE OF SUSPENDED SCAFFOLD TYPES

Suspended scaffold like supported scaffold has a mandate from OSHA that a competent person must be present during erection and dismantle, inspect each day before use and during any alteration of original set.

Erecting

Proper planning is key to any project. Consideration has to be giving to the structural integrity of the roof, anchor points and parapet walls if you are connecting to them. Inspection of all equipment must be done before installation to ensure there is no damage. Most of all safety concerns must be given for the workers installing the swing.

Use of Suspended Scaffold

Prior to every use a competent person must inspect the swing and corrective action taken if issues are found. A load should be applied each day and tighten all cable clamps to manufactures recommendation with the load on. Each person must have their own safety system anchored to its own anchorage point of 5000 lbs force. Never exceed the lowest load capacity of any component to avoid failure on the site. One should never use a suspended system in windy conditions.

Dismantling

Again an inspection must be performed by a competent person prior to dismantling the suspended scaffold. This will ensure the safety of those who are dismantling the suspended scaffold.

COMMONLY ASKED RULES OF SUSPENDED SCAFFOLD

- Each person must have their own fall arrest system and anchorage point of 5000 lbs capacity.
- Drop cables and life line must be long enough to reach the ground or lower roof.
- OSHA requires that motors are to be certified annually. **We do this for most manufactures call your rep for details.**
- Do not use any hoist on a system if it exceeds the capacity of the support system. Example if a beam system is rated for 1000 lbs do not use a 1500 lbs capacity hoist. This can cause the support system to fail.
- Guardrails are required on any open side where a man can fall through. The motor and stirrup can act as an end rail if it is no further than 18” from the end of the deck.
- Never use a suspended work platform when winds exceed 25 mph for 2 point or 20 mph for one point suspensions.
- Anchorage points are any structural items on the roof or PI tie back systems that with stand a 5000 lbs force or factor of safety of 4:1 (whichever is greater). **DO NOT** use air vents, electrical conduit, or standard piping.
- Tie backs must be perpendicular to the face of the building or you must do opposing angle tiebacks.
- Suspension cables and hardware must be capable of holding 6 times its intended load. So on a 1000 lbs hoist the cable must support at least 6000 lbs.
- Mixing of different manufactures equipment is ok as long as they fit together without force and are approved by a competent person.
- A Minimum of three clips (fist grips) must be used for suspension cables unless a factory or qualified person installs a swage. They should be checked after initial load is applied and also before each use there after. (torque to 30 ft lbs for 5/16 fist grips)
- On a two point suspension the deck should be a minimum of 18” wide unless one can show the necessity of less.
- No more than one person shall be on a deck rated at 250 lbs capacity, no more than two on a plank rated at 500 lbs, and no more than three on a deck rated for 750 lbs.
- No platform can be moved horizontally with a person on the platform.
- All scaffold (suspended or supported) must be a minimum of 10’ away from any energized power lines.
- Parapet clamps and cornice hooks must only be used on structural walls. Pour concrete walls or block walls that have been back filled with concrete. Never use on hollow brick walls.
- Counter weights must be made of none fluid material. Sandbags are never to be used as counter weights.
- Formula for proper counter weights to prevent uplift is as follow.

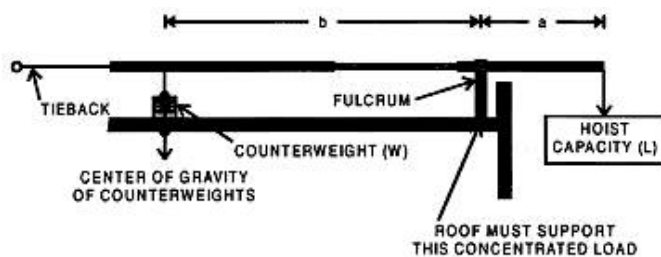

$$\text{Weight} = ((L * A) * 4) / B$$

“L” is the hoist capacity

“A” is the over hang of the beam (in front of the fulcrum point)

“4” is for the 4:1 safety factor

“B” is for the distance from the fulcrum point back to the counter weight

GENERAL COMPONENTS OF SUSPENDED SCAFFOLDING

This section will cover the basic components of a suspended scaffold system. There is much more that goes into it but this will give you an idea of what we rent and install. We have the support system, suspension system and safety system you need to complete you job safely.

Support System

The support system is considered all the roof rigging; like beams, parapet clamps, cornice hooks, tieback cables and counter weights. We have beam systems that can do a reach of 18' up to 10' along with one that can reach over 8' parapet walls and even one that can reach 5' down then go back under 4'.



RIG-PC-33
1500# Parapet Clamp
adjustable to a 27" wall



RS-BS
Beam Stand



Basic Beam System

Part#	Description	lbs
BEAM-F-10	10' Front Beam	42.0
BEAM-F-08	8' Front Beam	33.6
BEAM-M-08	8' Mid Beam	33.6
BEAM-R-08	8' Rear Beam	33.6
BEAM-S	Beam Splice	12.0
BEAM-S-8	Splice 5' Overhang	33.5

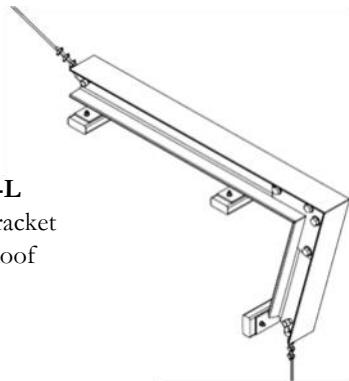

RIG-TB-L
L-Tieback Bracket
For Flat Roof

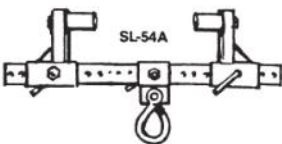
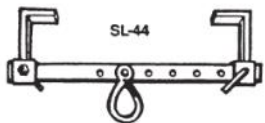

FIST
Wire Clamp

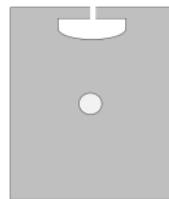

RIG-SCW
50# Steel Counter



RIG-PH
Pigeon Hole

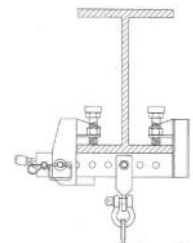

BC-BC2T
Beam Clamp 2 tons



RIG-TB
Tie Back Cable



RIG-SHACKLE
5/8 Screw Pin

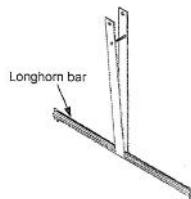

RIG-LH-T
Hanging Longhorn



RIG-LH1
Longhorn Bar



RIG-LH2
Saddle Style Longhorn

Rolling wheel (**RIG-WS** requires 2 per beam) can be added to the beams so you can move the beam without dismantling. It will have either a 36" or 48" overhang. Again no person shall be on a stage being moved horizontally



The Monorail System allows you to move the stage along the face of the wall horizontally without having to move rigging.

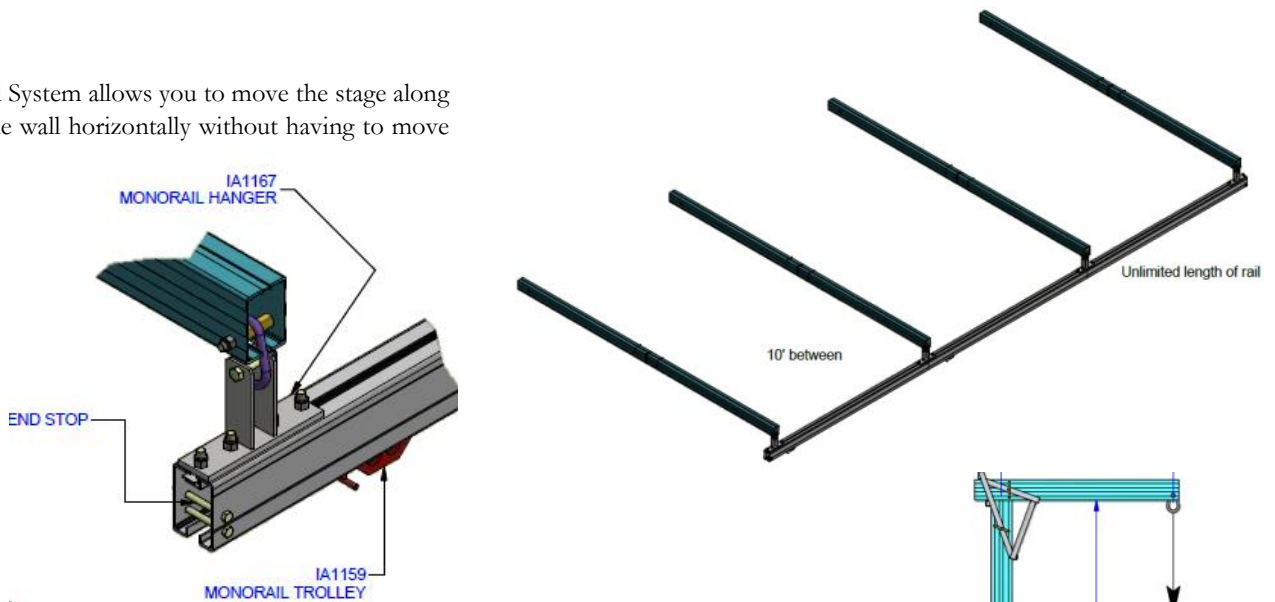

The System allows you to clear up to an 8' tall parapet wall without using scaffolding

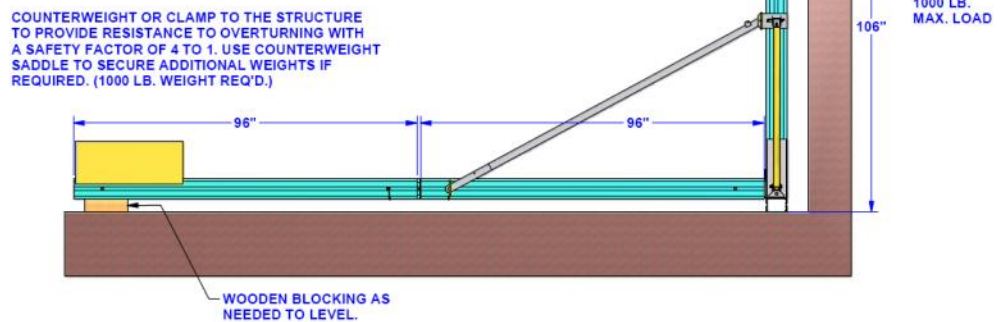

This over under system allows you to go down up to 5' and then go back under 1'-4'.

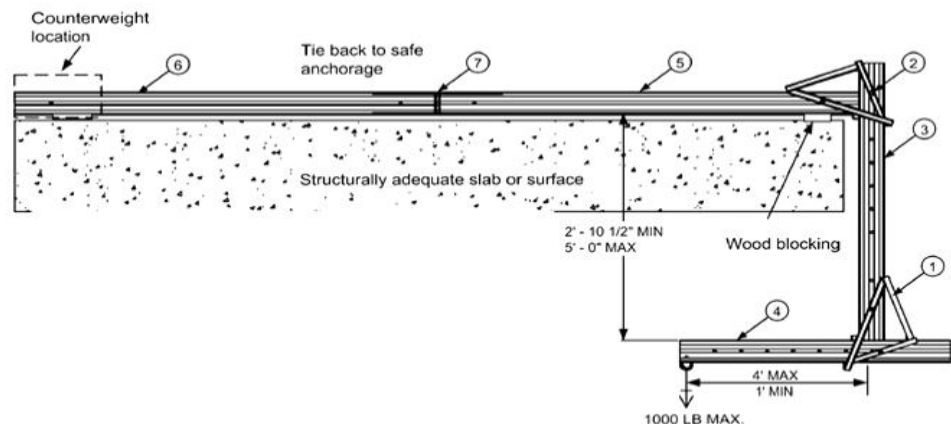

Suspension System

The suspension system includes the work platform, drop cables, motors, and power supply. As mentioned earlier there is three common work platform; bosun chair, work cage and a 2 point work stage. You can use a manual, air, and more common electric motors to lift the work platforms. They all have to be UL rated and have 4:1 safety factors built into the motors. Electric motor most often come in 110v or 220v with various load capacity. Remotes can be added to the motors if requested. The cable most commonly used in the construction industry is 5/16" cable and as far as power cord, the common is 10/3 SO with twist lock plugs.

SSI MOTORS	XE301	XE501	BIS-308	BIS-210	PCIDV	KCE1000	KCE1500	XA500
Capacity (lbs)	700	1000	1000	1500	1000	1000	1500	1000
Lift Speed (fpm)	35	35	35	35	35	32	32	30
Weight	79	123	94	128	104	104	120	91
Volts	110	220	220	220	220	220	220	85 PSI
Amps	5.2	9.5	9	9.5	7	7.5	9.24	60 CFM

Motors

The motors we rent are listed above, but many more kinds are available for special order (sizes and air type). OSHA requires the motors owned by end users be **certified by a factory certified mechanic annually**. We are the place to get your motors certified. We are certified by Bisomac, Sky Climber, Power Climber, and Tirak. Call your rep for pricing, damage to the motor.



Remotes



Tirak
XE301
XE501



Bisomac
BIS-308-1000
BIS-210-1500



Power Climber
PC1DV



Sky Climber
KCE1000
KCE1500

Power Supply & Cables

We rent and sell 10/3 power cords and 5/16 cables cut to the size you want. We also have power boosters for both 110v and 220v to help increase power for those long drops. For drops that exceed 100' we recommend using 220v motors. There is also a "step down" that can bring 220v power used on your motors down to 110v so you can run power tools from the deck. Our cables are swaged so no need for fist grips.



ELEC-PC
Power Cords



RIG-WR
5/16 Wire Rope



ELEC-YOKE-110
110v Yoke
ELEC-YOKE-220
220v Yoke
ELEC-YOKE-EXT
Yoke Extension



ELEC-ADAP
Various plugs
ELEC-PT
220v Pigtail

ELEC-PB-110
110v Booster
ELEC-PB-220
220v Booster



ELEC-SD
220v to 110v
Step down



ELEC-PC-SR
Strain Relief for
Power Cords



ELEC-ER
Edge Roller

Work Platforms



SKYDECK	UPSTAGE	Description	lbs
MOD-SD-PIN		Pins	1
MOD-SD-0.5M-D		1/2 Meter deck	8
MOD-SD-0.5M-S		1/2 Meter Side Frame	7
MOD-SD-0.5M-G		1/2 Meter Guardrail	1.5
MOD-SD-1M-D	MOD-UPS-1M-D	1 Meter Deck	15
MOD-SD-1M-S	MOD-UPS-1M-S	1 Meter Side Frame	14
MOD-SD-1M-G	MOD-UPS-1M-G	1 Meter Guardrail	3
MOD-SD-2M-D	MOD-UPS-2M-D	2 Meter Deck	27
MOD-SD-2M-S	MOD-UPS-2M-S	2 Meter Side Frame	26
MOD-SD-2M-G	MOD-UPS-2M-G	2 Meter Guardrail	5
MOD-SD-3M-D	MOD-UPS-3M-D	3 Meter Deck	37
MOD-SD-3M-S	MOD-UPS-3M-S	3 Meter Side Frame	37
MOD-SD-3M-G	MOD-UPS-3M-G	3 Meter Guardrail	7
MOD-SD-U	MOD-UPS-U	U-Frame	10
MOD-SD-P	MOD-UPS-P	Guardrail Post	2
STIRR-SD-E	STIRR-UPS-E	End Stirrup	32
MOD-SD-EP	MOD-UPS-EGRP	End Panel	15
STIRR-CORN-A		Adjustable Corner	132
MOD-SD-CR8	MOD-UPS-CR8	8" Caster	9



SKY STAGE ULTRA SAFE WORKING LOAD ONLY FOR CONFIGURATIONS WITH END STIRRUPS						SKY CLIMBER	
Max. Safe Working Load (uniformly distributed)	Suspension Distance	Self-Weight	Instructions for actual safe working load		Self-Weight	Suspension Distance	Max. Safe Working Load (uniformly distributed)
2000 lbs (900 kg)	6'9" (2m)	249lbs (113kg)	Add working load limit of hoists. Compare working load limit of hoist with max. safe working load of platform. The LOWfi ST rating is the ACTUAL SAFE WORKING LOAD. Read 'Installation Instructions' prior to assembling.		584lbs (265kg)	(9m) 29'3"	1000 lbs (450kg)
	9'9" (3m)	285lbs (129kg)			662lbs (300kg)	(10m) 33'0"	
	13'6" (4m)	363lbs (164kg)			698lbs (316kg)	(11m) 36'0"	
1500 lbs (680 kg)	16'6" (5m)	399lbs (181kg)			734lbs (333kg)	(12m) 39'0"	750 lbs (340kg)
	19'6" (6m)	435lbs (197kg)			811lbs (368kg)	(13m) 42'9"	
	23'3" (7m)	512lbs (232kg)			847lbs (384kg)	(14m) 45'9"	
	26'3" (8m)	548lbs (249kg)			883lbs (401kg)	(15m) 48'10"	



Part#	Desc	lbs
MOD-PMR-3M	3 Meter Tractel Deck	126
MOD-PMR-2M	2 Meter Tractel Deck	86
MOD-PMR-HC	Tractel Connectors	1
WC-WW	Work cage w/wire winder	45
MOD-PMR-EGR	End Panel	10





BOS-P or BOS-P-TRAC
Bosun Chair



BOS-M
Manual Bosun Chair



WC Work Cage 38" x 34.5"
WC-EXT Wings 86" x



WC-F
Folding Workcage
47" x 21"



934160
Hinged Porch Brackets
Use with Altrex or Skydeck



STIRR-PMR-C-A
C- Stirrup
STIRR-PMR-C-F
Folding C- Stirrup



STIRR
Plank Stirrup



STIRR-CORN-A
Adj Angular Stirrup

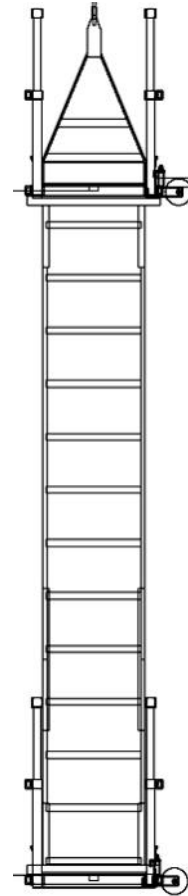

MOD-RB-W
Roller Bumpers

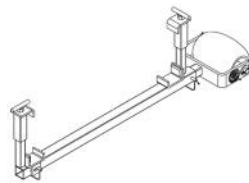

MOD-UPS-RB-EXT
Extendable Roller
36" max

Double Tier or Double Wide Stirrups

Part#	Description	Length
STIRR-DW	Double Wide	NA
RIG-DD-10	Multi Tier	10'
RIG-MTH-MOD-14	Multi Tier	14'
RIG-MTH-PIC-07	Multi Tier	7'

Temporary Roof Protection

The universal guardrail system is perfect to protect works from hazard of being on the roof. This system rents in 10' and 5' rail sections galvanized but powdercoat yellow is available for purchase. There is also a length 7'6" sections available for purchase. They exceed all OSHA requirements of 200 lbs. side force without failure and best of all they are 100% made in the USA. All base plates must be located a minimum distance of 18" for a "no curb"/parapet leading edge, or opening. If the work location has a curb or parapet edge, the base can be placed perpendicular against the rise of the structure.

PIECES FOR RENT



Meets 200lbs OHSA requirements



PIECE THAT MAY BE PURCHASED



For 300 lbs. Requirements in some states

Manufactured In:			
Individual Base Weight:	58 lbs.	108 lbs.	84 lbs.
Inches of Movement:	1"	6"	8"
Impact Load Resistance (lbs):	669+ lbs.	223 lbs.	168 lbs.



Safety System

The safety system or PFAS “Personal Fall Arrest System” is a key component to any suspended scaffold. They don't prevent falls from occurring but they stop you from serious injury or worse death should the main system fail. It has three components: anchorage point, body wear & connecting devices. We stock many basic items for sale but we can order just about anything you may want or need. There are major recurring errors that are found in the construction industry that impact job safety:

- Analyze the site for safety concerns up front before work begins, not after a fall occurs.
- Select appropriate anchorage point that can sustain a 5000 lbs force.
- Inspecting your equipment for wear and damage. The recommendation is every 3 years switch out your equipment and you must replace if involved in a fall.
- Lack of safety training to end users.
- Not knowing how to use safety equipment and also not knowing how to figure adequate fall clearance. (See below)
- Not using the equipment at all.

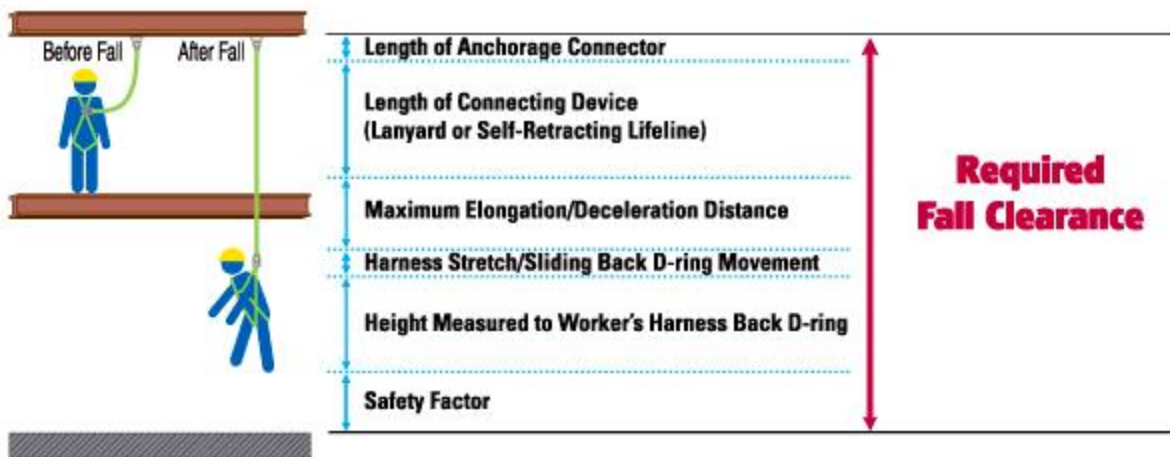

Fall Clearance Calculation (for Cross Arm Strap)

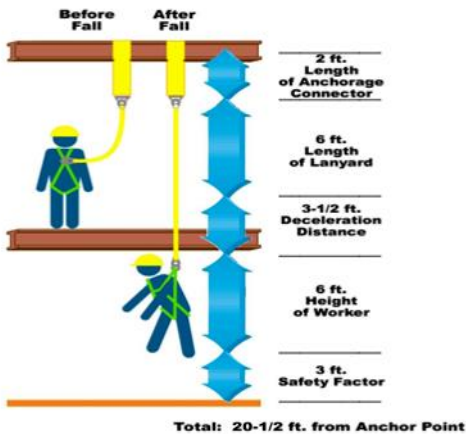

Fall Clearance Calculation (for Retractable Lifeline)

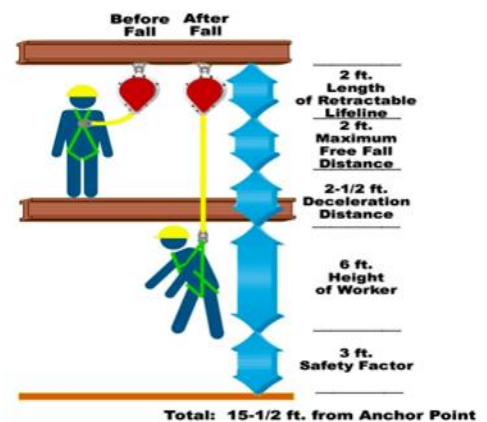

These are two samples of how to calculate the fall distance required. Always follow manufacturer's recommendation on required distances

Anchor Devices The anchor devices can be permanently install on roof tops or temporary. (see sample).



Tag Line Bladder



Permanent Roof Anchor



Reusable Anchor
Concrete



Roof Anchor



Beam Clamp



HM "HOLD ME"
This is used instead of tying knots in rope which can reduce the ropes capacity by 50%
Available in Red, Green, Blue, Orange
(Can be custom order with your Logo)



Cross Strap

Body Wear Devices (see sample).



Basic Harness



With support belt



Support Belt with
Positioning D



Positioning Belt

Connecting Devices (see sample).



Dual Lanyard



Rope Lanyard



6" lanyard



11' & 15' Retractable
Lanyard



carabiner



Rope Grab



5/8 safety rope cut to
length or spools of 600'



50' Retractable Lanyard

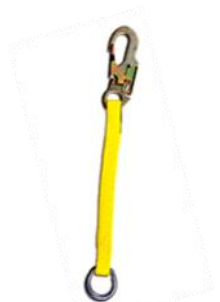

18" Extender

Material Handling

This section is to show you some common material handling equipment we handle for sales & rental.

RIG-ROLL

Rolling Outrigger
 1000 lbs capacity
 10' tall with 4" reach
 38-54" reach
 Parapet clearance
 5'9" - 10'9"



Maxial Hoist

Gemini & Leo's w/Scafrac



MH-TRAC-TU-17

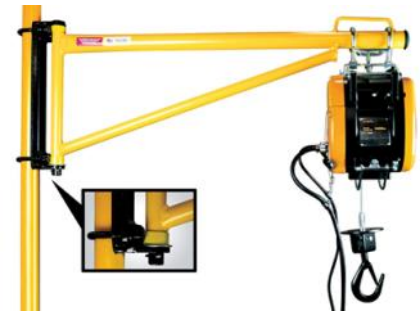

OZ-0500 & OZ-1000
 Hoist Arm OZ-HA

Maxial hoist can lift 450 lbs of material up to a maximum height of 250'. It will travel at a speed of 80' per minute.

	TU-17	Gemini Plus	Alpha 1000	TR30	TR50	OZ500	OZ1000
Capacity (lbs)	2,000	600	1,100	660	1,000	500	1,000
Lift Speed (fpm)	2 to 3	80	80	17	23	75	37
Weight	23	135	123	46	71	54	73
Volts	Manual	110	220	110	110	110	110

TR30 & TR50



Protect-It Roof System

MonZon's PROTECT-IT aluminum weather protection system will keep employees safe and protect your project against the elements. The system free spans widths of up to 165' and limitless lengths to fit any project. Its light weight, simple assembly and the fact that it fits on any system scaffold makes this the best solution around.

Basic Parts - Weather Protection

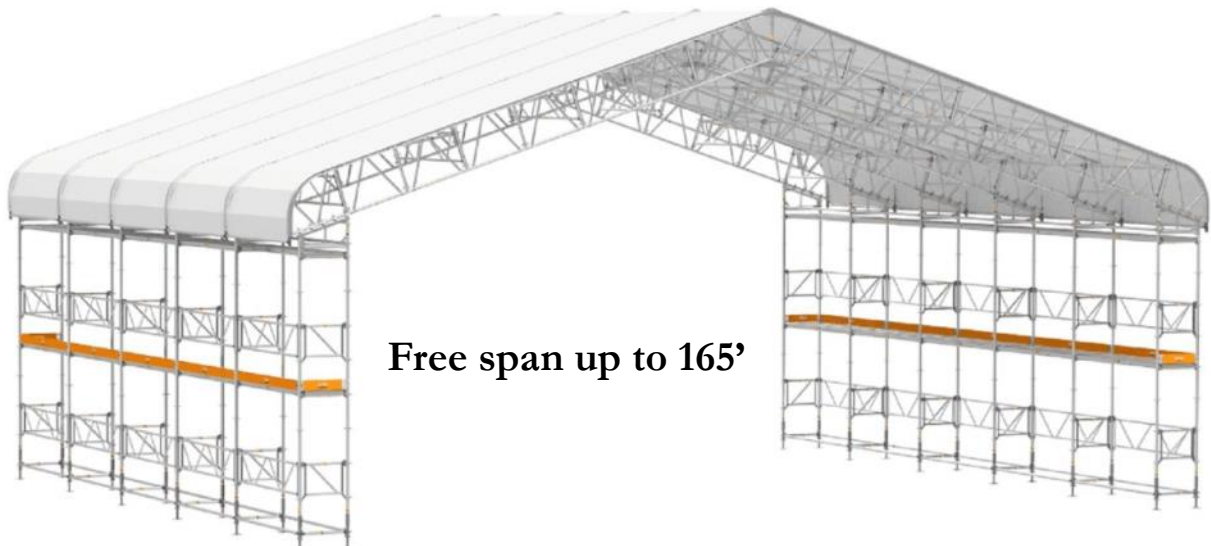
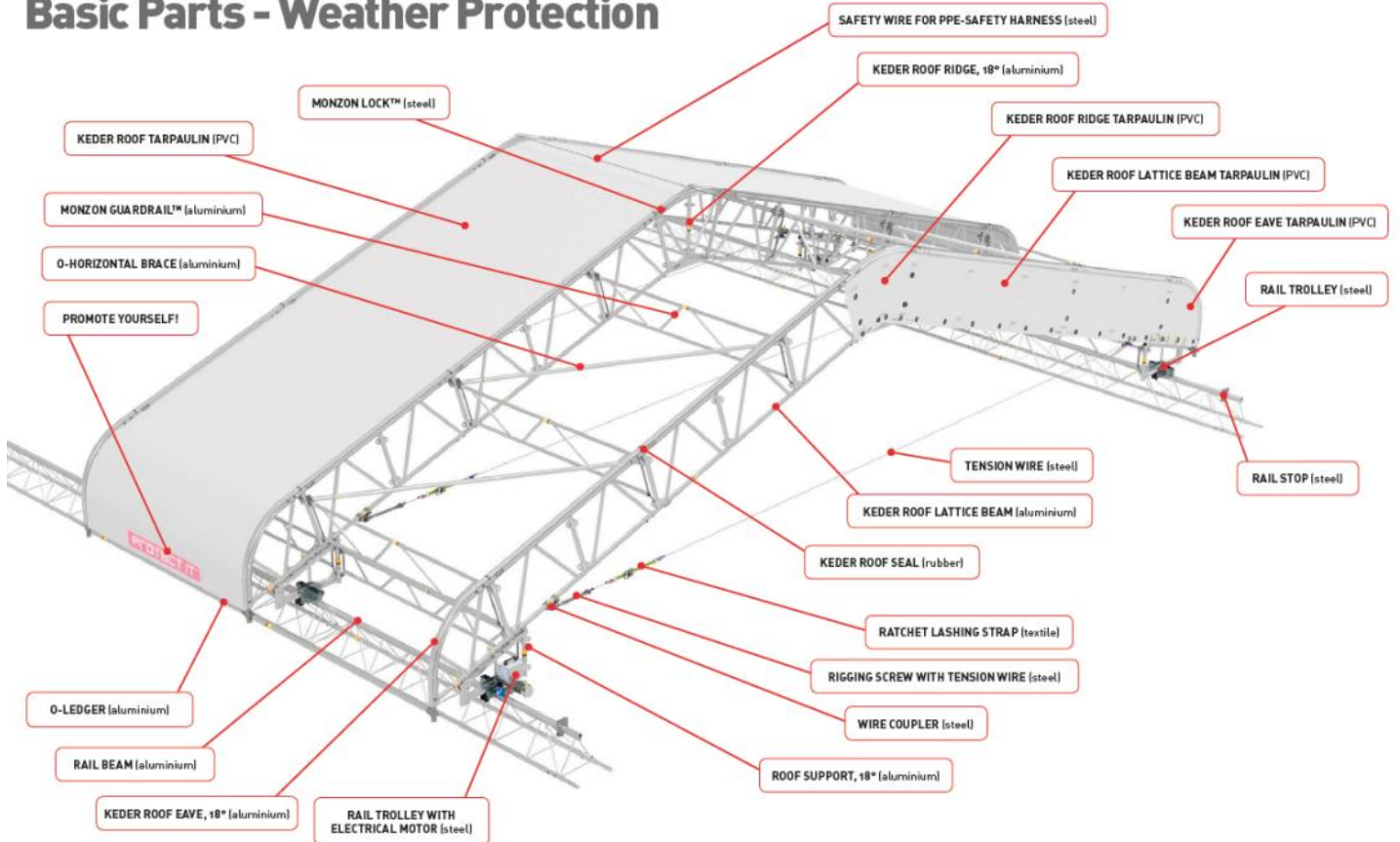

Free span up to 165'

Applications of Protect-It

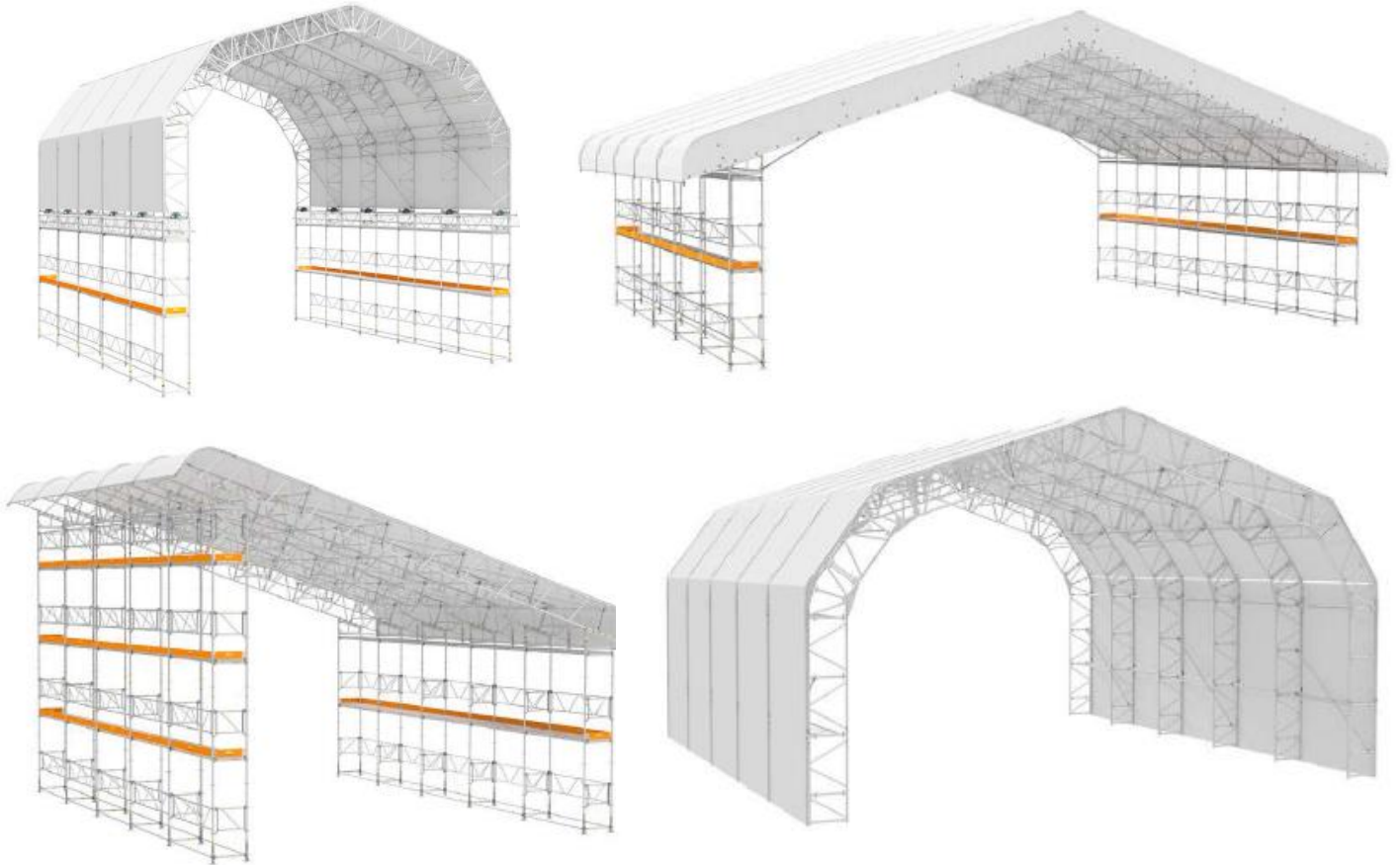

Some Major Components



Roof Support Frame



Roof Lattice Beam



Roof Ridge



Roof Eave



Rail Beam



Roof Support



**Roof Support
Rail Trolley**



Keder Roof Tarpaulin

Fraco Platforms FMC-3

New to the API—Scaffold Service Family is the Fraco line of work platforms. The FMC-3 is the perfect solutions for the light construction work & restoration. This reliable unit uses a rack & pinion lift system with a payload of 3000 pounds at a speed of 25' per minute on a single phase 220V system. On a single mast you can make a 33 foot long stage. We are a full line distributor of Fraco products so call you rep today for a quote.



TECHNICAL DATA

	IMPERIAL	METRIC
MAXIMUM LENGTH OF PLATFORM W/ SINGLE MAST (DOUBLE)	33 FT (100 FT)	10 M (30,5 M)
MAXIMUM PAYLOAD (SINGLE MAST CONFIGURATION)	3 000 LB	1 100 KG
LIFTING SPEED	25 FT / MIN	7,5 M / MIN
MAXIMUM WIDTH OF WORKING AREA (WITH 5 FT FLOOR EXTENSIONS)	8 FT 6 IN	2,6 M
MAXIMUM HEIGHT	395 FT	120 M
STANDARD DISTANCE BETWEEN ANCHORS	25 FT	7 M
LIFTING SYSTEM	RACK AND PINION (MODULE 6)	
TYPE OF ENGINE (POWER SUPPLY)	2 ELECTRICAL MOTORS 3KW (1 PHASE 220V / 60HZ)	
MOTORIZED UNIT (L X W X H) / WEIGHT	2 FT 6 IN X 3 FT X 4 FT 9 IN / 1 200 LB	1,36 M X 0,94 M X 1,44 M / 544 KG
MAST SECTION (L X W X H) / WEIGHT	17 3/4 IN X 17 3/4 IN X 5 FT / 170 LB	0,45 M X 0,45 M X 1,49 M / 77 KG
EXTENSIONS (L X W X H) / WEIGHT	5 FT 2 IN X 4 FT X 2 FT 11 IN / 230 LB	1,5 M X 1,2 M X 0,9 M / 104 KG
FLOOR EXTENSION (L X W X H) / WEIGHT	4 FT X 1 FT 5 IN X 3 IN / 30 LB	1,2 M X 0,43 M X 0,07 M / 13,6 KG
STANDARD COMPLIANCE	ANSI 92.9; CSA B354.7-17	

BetaMax MC4000/3000 Transport Platform

The New MC4000/3000 transport platform has a 3-4000# capacity, 13' long deck, 40 ft/m and a small foot print makes it the right choice for your job site. It is front or side load capable and with a 13' deck it is great for 12' drywall sheet. Its 40 feet per minute speed makes for fast and easy movement of equipment and crews. Height to 250'.

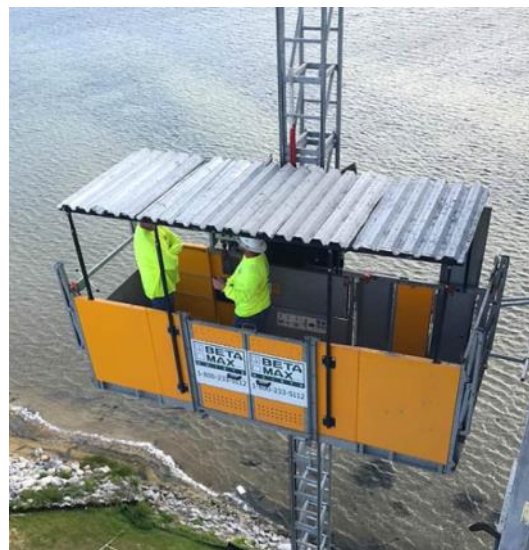
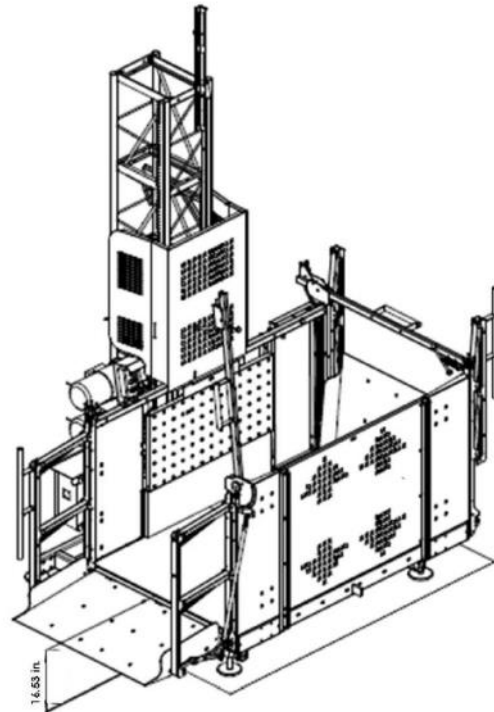

Debris Chutes

Chutes are used to bring debris from upper levels down to the ground without having to use stairs or elevators. They can be mounted in scaffolding, in a window, roof mounted or by other means. They come in various styles and diameters. We rent out molded plastic 32" chutes with top hopper and also intermediate hoppers to be able to have lower levels of putting in debris. You can get flat plastic or even steel chutes if you so choose. It is recommended that you have professionals like us install your chutes. When mounting the chute consideration must be given to the weight of the chute along with the force of the debris going down the chute. Items should be no larger than 18" long to avoid getting stuck in the chute thus creating a dam.



Part #	Description	lbs
DC-CHS	Chute Section	37.0
DC-CHH	Hopper	63.0
DC-CHF	Support Frame	69.0
DC-CHNO	No Touch Roof OR	818.0
DC-CHP	Parapet Outrigger	46.0
DC-CHW	Winch	71.0
DC-CHD	Intermediate Door	7.0





Parapet for Window or Parapet Roof

**must make sure structurally sound to support the weight of chute and material being tossed. Requires 38" open space in window*



Scaffold Attachment

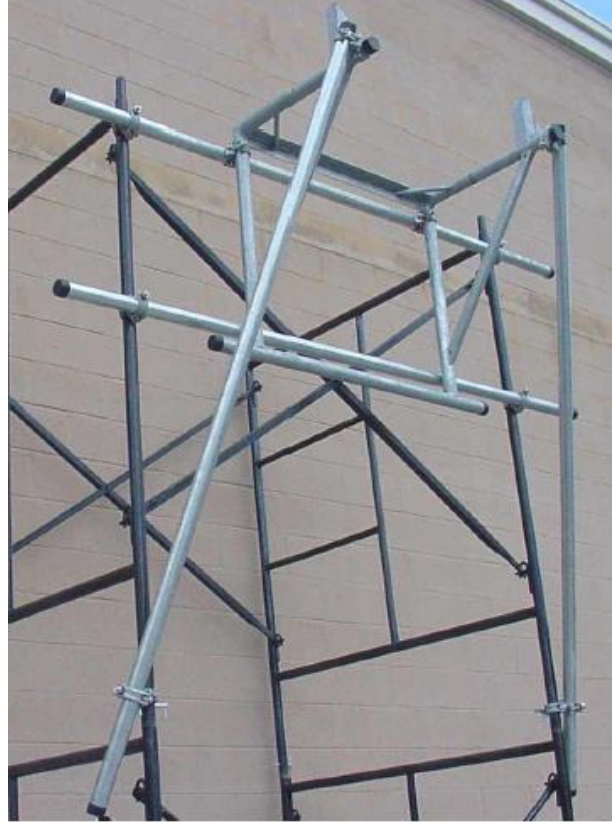

No – Touch Roof or window



Shoring

We partner with another company to provide you with your shoring needs and installation. Do to the situation that shoring is needed, we strongly recommend you have us figure out what you need for shoring. We can arrange to come out to your site and determine your exact needs to make it a safe project.

Titan Mega Shore Post & Standard Post

The titan is a lite weight component system that has an allowable load rating of 26,000 lbs per leg. It has 8' of adjustment between the top and bottom leg for perfect fit every time.

Shore Post Capacity In Our Rental House

Part#	Min	Max	3'-5'	7'	8'	9'	10'	11'	12'	13'	14'	15'
SH-P-0305	3'0"	5'0"	5500#									
SH-P-0611	6'6"	11'6"		7400#	6700#	6000#	5300#	4600#				
SH-P-1016	10'6"	16'6"						6591#	6060#	4755#	4180#	3606#



SCREW JACK
The TITAN screw jack provides a full 50" of adjustment and can be placed on both the top and the bottom of a Megashore leg for over 8' of total screw adjustment.

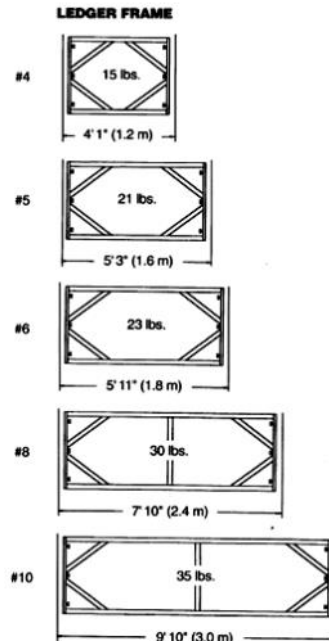
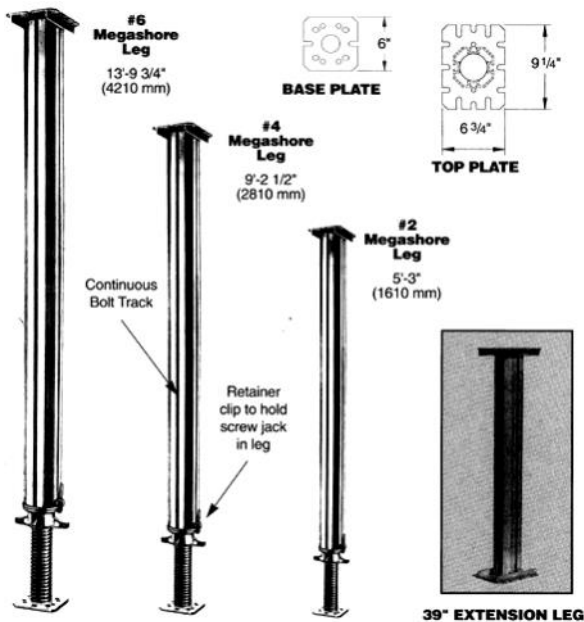
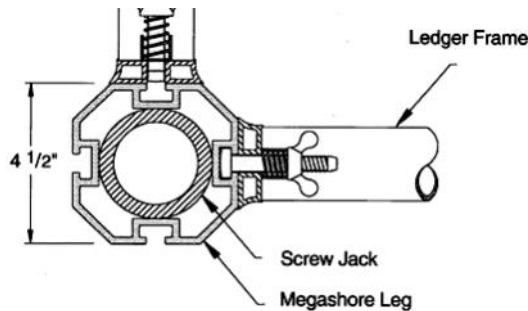
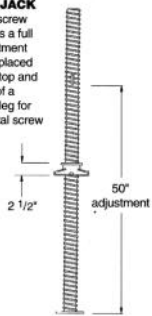

10M Heavy Duty Shoring

These frames have 2 1/2" OD legs that have an allowable load rating of 10,000 lbs per leg. The standard width is 4' wide and come in heights of 4', 5' and 6'.

Panels

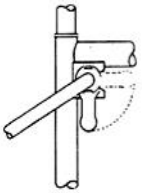
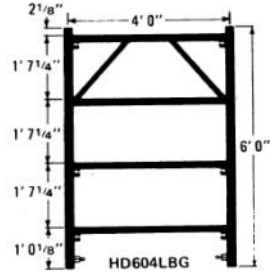
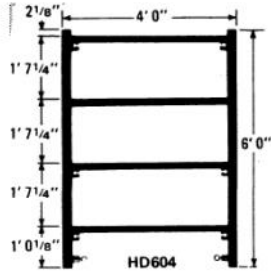
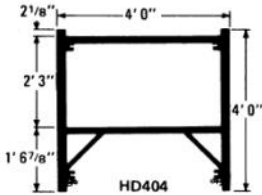

Cam Locks

All braces are connected to panels by means of Cam Locks, welded to the ends of each brace. To assemble, hold lever in a horizontal position, slide into cam box on panel and turn lever down. Brace is securely locked to the panel without tools or loose parts.

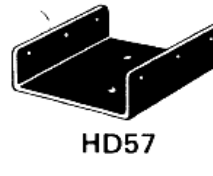

Shoring Beams

W6X12 Steel Beam Capacity of Single Beam

Span in Feet	Center Point Load			Uniform Load		
	Load in Pounds	Deflection in Inches	Limiting Factor	Load in lbs/foot	Deflection in Inches	Limiting Factor
2.0	29,240	1/64	SM	28,992	1/64	SM
2.5	23,392	1/64	SM	18,552	1/64	SM
3.0	19,493	1/32	SM	12,888	1/32	SM
4.0	14,620	3/64	SM	7,248	1/16	SM
5.0	11,696	5/64	SM	4,632	7/64	SM
6.0	9,746	7/64	SM	3,216	5/32	SM
7.0	8,354	11/64	SM	2,364	15/64	SM
8.0	7,310	7/32	SM	1,740	1/4	DEF
9.0	6,106	1/4	DEF	1,056	1/4	DEF
10.0	4,450	1/4	DEF	696	1/4	DEF
11.0	3,343	1/4	DEF	468	1/4	DEF
12.0	2,575	1/4	DEF	336	1/4	DEF

Aluma Beam 6.5" Tall

Uniform Load - 1 Beam	
Span in Feet	Load in lbs/foot
4.0	3,080
4.5	2,740
5.0	2,020
5.5	1,510
6.0	1,160
6.5	920
7.0	730
7.5	595
8.0	490
8.5	405
9.0	345
9.5	295
10.0	250

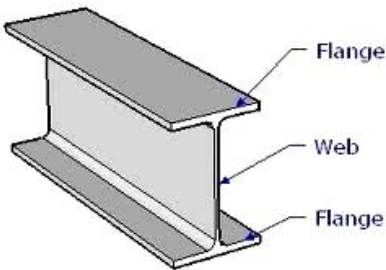

These chart requires a minimum of 2" of beam to be beyond the bearing point on each side of the beam.
 SM= Section Modulus (beam would fail before max deflection is reached)
 DEF= Deflection (maximum allowable deflection of beam is reached before beam would fail)

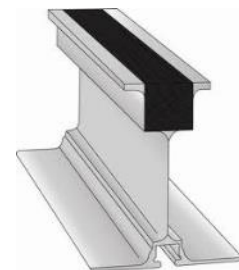

Competent Person Training

We are an accredited training facility for the SAIA “Scaffold & Access Industry Association”. We do the training at our facility or if you have eight or more we will come to your site. The classes we teach are for frame scaffold, system scaffold or suspended scaffold. Included in the cost is a book you will receive in advance to read before coming to class. There is about an eight hour in class tutor with the instructor and then a test. We try to keep the class size to a maximum of 12 to ensure everyone gets special attention. You will receive a certificate and a wallet card if you pass which is good for three years. Prior to it expiring you will get a notice for a refresher course which is about 4 hours in class and then a test. Call your rep today to find out cost and when the next classes are scheduled.

Benefits to CPT Training

- Helps to provide a safer workplace for employees and customers
- Helps to meet government requirements
- Helps to meet insurance requirements
- Helps to meet competent person training requirements
- Provide structure for career advancement for employees
- Create an objective standard for new employee assessment by independent not-for-profit organization
- Potential insurance savings



CODE OF SAFE PRACTICES FOR

FRAME SCAFFOLDS, SYSTEM SCAFFOLDS, TUBE AND CLAMP SCAFFOLDS & ROLLING SCAFFOLDS
DEVELOPED FOR INDUSTRY BY **SCAFFOLDING, SHORING & FORMING INSTITUTE (SSFI)**
and **SCAFFOLD INDUSTRY ASSOCIATION, INC. (SIA)**

It shall be the responsibility of all users to read and comply with the following common sense guidelines which are designed to promote safety in the erecting, dismantling and use of Scaffolds. These guidelines do not purport to be all inclusive nor to supplant or replace other additional safety and precautionary measures to cover usual or unusual conditions. If these guidelines in any way conflict with any state, local, provincial, federal or other government statute or regulation, said statute or regulation shall supersede these guidelines and it shall be the responsibility of each user to comply therewith.

I. GENERAL GUIDELINES

- A. POST THESE SCAFFOLDING SAFETY GUIDELINES** in a conspicuous place and be sure that all persons who erect, dismantle, or use scaffolding are aware of them, and also use them in tool box safety meetings.
- B. FOLLOW ALL STATE, LOCAL AND FEDERAL CODES, ORDINANCES AND REGULATIONS** pertaining to scaffolding.
- C. SURVEY THE JOB SITE.** A survey shall be made of the job site by a competent person for hazards, such as untamped earth fills, ditches, debris, high tension wires, unguarded openings, and other hazardous conditions created by other trades. These conditions should be corrected or avoided as noted in the following sections.
- D. INSPECT ALL EQUIPMENT BEFORE USING.** Never use any equipment that is damaged or defective in any way. Mark it or tag it as defective. Remove it from the job site.
- E. SCAFFOLDS MUST BE ERECTED IN ACCORDANCE WITH DESIGN AND/OR MANUFACTURERS' RECOMMENDATIONS.**
- F. DO NOT ERECT, DISMANTLE OR ALTER A SCAFFOLD** unless under the supervision of a competent person.
- G. DO NOT ABUSE OR MISUSE THE SCAFFOLD EQUIPMENT.**
- H. ERECTED SCAFFOLDS SHOULD BE CONTINUALLY INSPECTED** by users to be sure that they are maintained in safe condition. Report any unsafe condition to your supervisor.
- I. NEVER TAKE CHANCES! IF IN DOUBT REGARDING THE SAFETY OR USE OF THE SCAFFOLD, CONSULT YOUR SCAFFOLD SUPPLIER.**
- J. NEVER USE EQUIPMENT FOR PURPOSES OR IN WAYS FOR WHICH IT WAS NOT INTENDED.**
- K. DO NOT WORK ON SCAFFOLDS** if your physical condition is such that you feel dizzy or unsteady in any way.
- L. DO NOT WORK UNDER THE INFLUENCE** of alcohol or illegal drugs.

II. GUIDELINES FOR ERECTION AND USE OF SCAFFOLDS

- A. SCAFFOLD BASE MUST BE SET ON BASE PLATES AND AN ADEQUATE SILL OR PAD** to prevent slipping or sinking and fixed thereto where required. Any part of a building or structure used to support the scaffold shall be capable of supporting the maximum intended load to be applied.
- B. USE ADJUSTING SCREWS** or other approved methods to adjust to uneven grade conditions.
- C. BRACING, LEVELING & PLUMBING OF FRAME SCAFFOLDS-**
 - 1. Plumb and level all scaffolds as erection proceeds. Do not force frames or braces to fit. Level the scaffold until proper fit can be easily made.
 - 2. Each frame or panel shall be braced by horizontal bracing, cross bracing, diagonal bracing or any combination thereof for securing vertical members together laterally. All brace connections shall be made secure, in accordance with the manufacturer's recommendations.
- D. BRACING, LEVELING & PLUMBING OF TUBE & CLAMP AND SYSTEM SCAFFOLDS-**
 - 1. Posts shall be erected plumb in all directions, with the first level of runners and bearers positioned as close to the base as feasible. The distance between bearers and runners shall not exceed manufacturer's recommendations.
 - 2. Plumb and level all scaffolds as erection proceeds.
 - 3. Fasten all couplers and/or connections securely before assembly of next level.
 - 4. Vertical and/or horizontal diagonal bracing must be installed according to manufacturer's recommendations.
- E. WHEN FREE STANDING SCAFFOLD TOWERS exceed a height of four (4) times their minimum base dimension,** they must be restrained from tipping. (CAL/OSHA and some government agencies require stricter ratio of 3 to 1.)
- F. TIE CONTINUOUS (RUNNING) SCAFFOLDS TO THE WALL OR STRUCTURE at each end and at least every 30 feet of length in between when scaffold height exceeds the maximum allowable free standing dimension. Install additional ties on taller scaffolds as follows:** On scaffolds 3 feet or narrower in width, subsequent vertical ties shall be repeated at intervals no greater than every 20 feet. On scaffolds wider than 3 feet, subsequent vertical ties shall be repeated at intervals not greater than 26 feet. The top tie shall be installed as close to the top of the platform as possible; however, no lower from the top than 4 times the scaffold's minimum base dimension. Ties must prevent the scaffold from tipping either into or away from the structure. Stabilize circular or irregular scaffolds in such a manner that the completed scaffold is secure from tipping. Place ties near horizontal members. When scaffolds are fully or partially enclosed, or when scaffolds are subjected to overturning loads, additional ties may be required. Consult a qualified person.
- G. DO NOT ERECT SCAFFOLDS NEAR ELECTRICAL POWER LINES.** Consult a qualified person for advice.
- H. ACCESS SHALL BE PROVIDED TO ALL PLATFORMS.** Do not climb crossbraces or diagonal braces.

- I. PROVIDE A GUARDRAIL SYSTEM, FALL PROTECTION AND TOEBOARDS WHERE REQUIRED BY THE PREVAILING CODE.**
- J. BRACKETS AND CANTILEVERED PLATFORMS-**
1. Brackets for system scaffolds shall be installed and used in accordance with manufacturer's recommendations.
 2. Brackets for frame scaffolds shall be seated correctly with side bracket parallel to the frames and end brackets at 90 degrees to the frames. Brackets shall not be bent or twisted from normal position. Brackets (except mobile brackets designed to carry materials) are to be used as work platforms only and shall not be used for storage of material or equipment.
 3. Cantilevered platforms shall be designed, installed and used in accordance with manufacturers' recommendations.
- K. ALL SCAFFOLDING COMPONENTS** shall be installed and used in accordance with the manufacturers' recommended procedure. Components shall not be altered. Scaffold frames and their components manufactured by different companies shall not be intermixed, unless the component parts readily fit together and the resulting scaffold's structural integrity is maintained by the user.
- L. PLANKING-**
1. Working platforms shall cover scaffold bearer as completely as possible. Only scaffold grade wood planking, or fabricated planking and decking meeting scaffold use requirements shall be used. Planks and platforms should rest on bearers only.
 2. Check each plank prior to use to be sure plank is not warped, damaged, or otherwise unsafe.
 3. Planking shall have at least 12" overlap and extend 6" beyond center of support, or be cleated or restrained at both ends to prevent sliding off supports.
 4. Solid sawn lumber, LVL (laminated veneer lumber) or fabricated scaffold planks and platforms (unless cleated or restrained) shall extend over their end supports not less than 6" nor more than 18". This overhang should be guardrailed to prevent access.
- M. FOR "PUTLOGS" AND "TRUSSES" THE FOLLOWING ADDITIONAL GUIDELINES APPLY:**
1. Do not cantilever or extend putlogs/trusses as side brackets without thorough consideration of loads to be applied.
 2. Install and brace putlogs and trusses in accordance with manufacturer's instructions.
- N. FOR ROLLING SCAFFOLDS THE FOLLOWING ADDITIONAL GUIDELINES APPLY:**
1. **RIDING A ROLLING SCAFFOLD IS VERY HAZARDOUS.** The SSFI and the SIA do not recommend nor encourage this practice.
 2. Casters with plain stems shall be attached to the frames or adjustment screws by pins or other suitable means.
 3. No more than 12 inches of the screw jack shall extend between the bottom of the adjusting nut and the top of the caster.
 4. Wheels or casters shall be locked to prevent caster rotation and scaffold movement when scaffold is in use.
 5. Joints shall be restrained from separation.
 6. Use horizontal diagonal bracing near the bottom and at 20 foot intervals measured from the rolling surface.
 7. Do not use brackets or other platform extensions without compensating for the overturning effect.
 8. The top platform height **as measured from the rolling surface** of a rolling scaffold must not exceed four (4) times the smallest base dimension (CAL/OSHA and some government agencies require a stricter ratio of 3:1).
 9. Cleat or secure all plank.
 10. Secure or remove all materials and equipment from platform before moving.
 11. Do not attempt to move a rolling scaffold without sufficient help - watch out for holes in floor and overhead obstructions - stabilize against tipping.
- O. SAFE USE OF SCAFFOLD-**
1. Prior to use, inspect scaffold to insure it has not been altered and is in safe working condition.
 2. Erected scaffolds and platforms should be inspected continuously by those using them.
 3. Exercise caution when entering or leaving a work platform.
 4. Do not overload scaffold. Follow manufacturer's safe working load recommendations.
 5. Do not jump onto planks or platforms.
 6. **DO NOT USE** ladders or makeshift devices to increase the working height of a scaffold. Do not plank guardrails to increase the height of a scaffold.
 7. Climb in access areas only and use both hands.

III. WHEN DISMANTLING SCAFFOLDING THE FOLLOWING ADDITIONAL GUIDELINES APPLY:

- A.** Check to assure scaffolding has not been structurally altered in a way which would make it unsafe and, if it has, reconstruct and/or stabilize where necessary before commencing with dismantling procedures. This includes all scaffold ties.
- B.** Visually inspect planks prior to dismantling to be sure they are safe.
- C.** Do not remove a scaffold component without considering the effect of that removal.
- D.** Do not accumulate excess components or equipment on the level being dismantled.
- E.** Do not remove ties until scaffold above has been dismantled to that level.
- F.** Lower dismantled components in an orderly manner. Do not throw off of scaffold.
- G.** Dismantled equipment should be stockpiled in an orderly manner.

Since field conditions vary and are beyond the control of the SSFI and the SIA, safe and proper use of scaffolding is the sole responsibility of the user.

Reprinting of this publication does not imply approval of product by the Institute or indicate membership in the Institute. © Permission to reproduce in entirety can be obtained from: Scaffolding, Shoring & Forming Institute, 1300 Sumner Ave., Cleveland, Ohio 44115

CODE OF SAFE PRACTICES
FOR
SUSPENDED SCAFFOLDS
DEVELOPED FOR INDUSTRY BY **SCAFFOLDING, SHORING & FORMING INSTITUTE (SSFI)**
and **SCAFFOLD INDUSTRY ASSOCIATION, INC. (SIA)**

It shall be the responsibility of all users to read and comply with the following common sense guidelines which are designed to promote safety in the erecting, dismantling and use of suspended scaffolds. These guidelines do not purport to be all-inclusive nor to supplant or replace other additional safety and precautionary measures to cover usual or unusual conditions. If these guidelines in any way conflict with any state, local, provincial, federal or other government statute or regulation, said statute or regulation shall supersede these guidelines and it shall be the responsibility of each user to comply therewith.

I. GENERAL GUIDELINES

- A. POST THESE SAFETY GUIDELINES** in a conspicuous place and be sure that all persons who erect, use, locate, or dismantle suspended scaffold systems are fully aware of them and also use them in tool box safety meetings.
- B. FOLLOW ALL EQUIPMENT MANUFACTURERS' RECOMMENDATIONS** as well as all state, local and federal codes, ordinances and regulations relating to suspended scaffolding.
- C. SURVEY THE JOB SITE.** A survey shall be made of the job site by a competent person for hazards such as exposed electrical wires, obstructions that could overload or tip the suspended scaffold when it is raised or lowered, unguarded roof edges or openings, inadequate or missing tiebacks. Those conditions should be corrected before installing or using suspended scaffold systems.
- D. INSPECT ALL EQUIPMENT BEFORE EACH USE.** Never use any equipment that is damaged or defective in any way. Mark it or tag it as damaged or defective equipment and remove it from the jobsite.
- E. ERECT AND DISMANTLE SUSPENDED SCAFFOLD EQUIPMENT** in accordance with design and / or manufacturer's recommendations.
- F. DO NOT ERECT, DISMANTLE, OR ALTER SUSPENDED SCAFFOLD SYSTEMS** unless under the supervision of a competent person.
- G. DO NOT ABUSE OR MISUSE SUSPENDED SCAFFOLD EQUIPMENT.** Never overload platforms or hoists.
- H. ERECTED SUSPENDED SCAFFOLDS SHOULD BE CONTINUOUSLY INSPECTED** by the user to be sure that they are maintained in a safe condition. Report any unsafe condition to your supervisor.
- I. NEVER TAKE CHANCES! IF IN DOUBT REGARDING THE SAFETY OR USE OF SUSPENDED SCAFFOLDS, CONSULT YOUR SCAFFOLD SUPPLIER.**
- J. NEVER USE SUSPENDED SCAFFOLD EQUIPMENT FOR PURPOSES OR IN OTHER WAYS FOR WHICH IT WAS NOT INTENDED.**
- K. CARE SHOULD BE TAKEN WHEN OPERATING AND STORING EQUIPMENT DURING WINDY CONDITIONS.**
- L. SUSPENDED SCAFFOLD SYSTEMS** should be installed and used in accordance with the manufacturer's recommended procedures. Do not alter components in the field.
- M. SUSPENDED PLATFORMS MUST NEVER BE OPERATED NEAR LIVE POWER LINES** unless proper precautions are taken. Consult the power service company for advice.
- N. ALWAYS ATTACH FALL ARREST EQUIPMENT** when working on suspended scaffolds.
- O. DO NOT WORK ON OR INSTALL SUSPENDED SCAFFOLDS** if your physical condition is such that you feel dizzy or unsteady in any way.
- P. DO NOT WORK ON SUSPENDED SCAFFOLDS** when under the influence of alcohol or illegal drugs.

II. GUIDELINES FOR ERECTION AND USE OF SUSPENDED SCAFFOLD SYSTEMS

A. RIGGING:

- 1. WEAR FALL PREVENTION EQUIPMENT** when rigging on exposed roofs or floors.
- 2. ROOF HOOKS, PARAPET CLAMPS, OUTRIGGER BEAMS, OR OTHER SUPPORTING DEVICES** must be capable of supporting the hoist machine rated load with a factor of safety of 4.
- 3. VERIFY THAT THE BUILDING OR STRUCTURE WILL SUPPORT** the suspended loads with a factor of safety of 4.
- 4. ALL OVERHEAD RIGGING** must be secured from movement in any direction.

5. **COUNTERWEIGHTS USED WITH OUTRIGGER BEAMS** must be of a non-flowable material and must be secured to the beam to prevent accidental displacement.
 6. **OUTRIGGER BEAMS THAT DO NOT USE COUNTERWEIGHTS** must be installed and secured on the roof structure with devices specifically designed for that purpose. Direct connections shall be evaluated by a competent person.
 7. **TIE BACK ALL TRANSPORTABLE RIGGING DEVICES.** Tiebacks shall be equivalent in strength to suspension ropes.
 8. **INSTALL TIEBACKS AT RIGHT ANGLES TO THE FACE OF THE BUILDING** and secure, without slack, to a structurally sound portion of the structure, capable of supporting the hoisting machine rated load with a safety factor of 4. **IN THE EVENT THAT TIEBACKS CANNOT BE INSTALLED AT RIGHT ANGLES,** two tiebacks at opposing angles must be used to prevent movement.
 9. **RIG AND USE HOISTING MACHINES DIRECTLY UNDER THEIR SUSPENSION POINTS.**
- B. WIRE ROPE AND HARDWARE:**
1. **USE ONLY WIRE ROPE AND ATTACHMENTS** as specified by the hoisting machine manufacturer.
 2. **ASSURE THAT WIRE ROPE IS LONG ENOUGH** to reach to the lowest possible landing.
 3. **CLEAN AND LUBRICATE WIRE ROPE** in accordance with the wire rope manufacturer's instructions.
 4. **HANDLE WIRE ROPE WITH CARE.**
 5. **COIL AND UNCOIL WIRE ROPE** in accordance with manufacturer's instructions in order to avoid kinks or damage.
 6. **TIGHTEN WIRE ROPE CLAMPS** in accordance with the clamp manufacturer's instructions.
 7. **INSPECT WIRE ROPE IN ACCORDANCE WITH MANUFACTURER'S INSTRUCTIONS. DO NOT USE WIRE ROPE THAT IS KINKED, BIRDCAGED, CORRODED, UNDERSIZED, OR DAMAGED IN ANY WAY.** Do not expose wire rope to fire, undue heat, corrosive atmosphere, electricity, chemicals or damage by tool handling.
 8. **USE THIMBLES AND SHACKLES AT ALL WIRE ROPE SUSPENSION TERMINATIONS.**
 9. **USE J-TYPE CLAMPS OR SWEDGE FITTINGS.** Do not use U-bolts. Retighten J Clamps under load and retighten daily.
 10. **WIRE ROPES USED WITH TRACTION HOISTS MUST HAVE PREPARED ENDS.** Follow manufacturer's recommendations.
- C. POWER SUPPLY FOR MOTORIZED EQUIPMENT:**
1. **GROUND ALL ELECTRICAL POWER SOURCES AND POWER CORD CONNECTIONS** and protect them with circuit breakers.
 2. **USE POWER CORDS OR AIR HOSES OF THE PROPER SIZE THAT ARE LONG ENOUGH** for the job.
 3. **POWER CORD OR AIR HOSE CONNECTIONS MUST BE RESTRAINED** to prevent their separation.
 4. **USE STRAIN RELIEF DEVICES TO ATTACH POWER CORDS OR AIR SUPPLY HOSES TO THE SUSPENDED SCAFFOLD** to prevent them from falling.
 5. **PROTECT POWER CORDS OR AIR HOSES AT SHARP EDGES.**
 6. **USE GFI WITH POWER TOOLS.**
- D. FALL ARREST EQUIPMENT:**
1. **EACH PERSON ON A SUSPENDED SCAFFOLD** must be attached to a separate fall arrest system unless the installation was specifically designed not to require one.
 2. **EACH LIFELINE MUST BE FASTENED IN ACCORDANCE WITH MANUFACTURER'S INSTRUCTIONS** to a separate anchorage capable of holding a minimum of 5000 pounds.
 3. **DO NOT WRAP LIFELINES AROUND STRUCTURAL MEMBERS** unless lifelines are protected and a suitable anchorage connection is used.
 4. **PROTECT LIFELINES AT SHARP CORNERS** to prevent chafing.
 5. **RIG FALL ARREST SYSTEMS** to prevent free fall in excess of six feet.
 6. **SUSPEND LIFELINES FREELY** without contact with structural members or building façade.
 7. **USE LIFELINES OF SIZE AND CONSTRUCTION** that are compatible with the rope grab use.
 8. **ASSURE A PROPERLY ATTACHED ROPE GRAB IS INSTALLED ON EACH LIFELINE IN THE PROPER DIRECTION.** Install in accordance with the manufacturer's recommendations.
 9. **KEEP ROPE GRAB POSITIONED ABOVE YOUR HEAD LEVEL.**
 10. **USE ONLY FULL BODY HARNESES** of the proper size and that are tightly fastened.
 11. **ASSURE FULL BODY HARNESS HAS LANYARD** attachment with D-ring at the center of your back.

12. CONSULT FALL PROTECTION SUPPLIER FOR INSPECTION PROCEDURE. INSPECT FALL PROTECTION ANCHORAGE / EQUIPMENT BEFORE EACH USE.

13. WHEN A SECONDARY WIRE ROPE SYSTEM IS USED, a horizontal lifeline secured to two or more structural members of the scaffold in lieu of vertical lifelines.

E. DURING USE:

- 1. USE ALL EQUIPMENT AND ALL DEVICES** in accordance with the manufacturer's instructions.
- 2. DO NOT OVERLOAD, MODIFY, OR SUBSTITUTE EQUIPMENT.**
- 3. BEFORE COMMENCING WORK OPERATIONS** preload wire rope and equipment with the maximum working load, then retighten wire rope rigging clamps and recheck rigging to manufacturer's recommendations.
- 4. INSPECT ALL RIGGING EQUIPMENT AND SUSPENDED SCAFFOLD SYSTEMS DAILY.**
- 5. INSPECT WIRE ROPE DURING EACH ASCENT OR DESCENT FOR DAMAGE.**
- 6. USE CARE TO PREVENT DAMAGE TO EQUIPMENT** by corrosive or other damaging substances.
- 7. CLEAN AND SERVICE EQUIPMENT REGULARLY.**
- 8. ALWAYS MAINTAIN AT LEAST (4) FOUR WRAPS OF WIRE ROPE ON DRUM TYPE HOISTS.**
- 9. DO NOT JOIN PLATFORMS** unless the installation was designed for that purpose.
- 10. ONLY MOVE SUSPENDED SCAFFOLDS HORIZONTALLY WHEN NOT OCCUPIED.**
- 11. WHEN RIGGING FOR ANOTHER DROP** assure sufficient wire rope is available before moving the suspended scaffold system horizontally.
- 12. WHEN WELDING FROM SUSPENDED SCAFFOLDS:**
 - a. Assure platform is grounded to structure.
 - b. Insulate wire rope above and below the platform.
 - c. Insulate wire rope at suspension point and assure wire does not contact structure along its entire length.
 - d. Prevent the bitter end from touching the welding ground.

Since field conditions vary and are beyond the control of the SSFI and the SIA, safe and proper use of suspended scaffolding is the sole responsibility of the user.

Reprinting of this publication does not imply approval of product by the Institute or indicate membership in the Institute.
© Permission to reproduce in entirety can be obtained from: Scaffolding, Shoring & Forming Institute, 1300 Sumner Ave., Cleveland, Ohio 44115

Proud Family of Partners

